

37.014.22

A37 di

MÁS VALE TARDE QUE NUNCA



ALFABETIZACIÓN A DISTANCIA  
Cuaderno Introdutorio  
1988

INVENTARIO 016742
SIG. TOP. 37.017.22
AS7 di



República Argentina  
Ministerio de Educación y Justicia  
Comisión Nacional de Alfabetización  
Funcional y Educación Permanente

**MÁS VALE TARDE QUE NUNCA**

**ALFABETIZACIÓN A DISTANCIA  
CUADERNO INTRODUCTORIO**



PLAN NACIONAL  
DE ALFABETIZACION

**1988**

Centro Nac. Información  
Documental Educativa  
Pizzurno 935 Sub. Suelo  
(1926) Ciudad Autónoma de Bs. As.  
República Argentina

Primera Edición - Buenos Aires - 1988

**LIBRO DE EDICION ARGENTINA**

© - MINISTERIO DE EDUCACION Y JUSTICIA -  
COMISION NACIONAL DE ALFABETIZACION  
FUNCIONAL Y EDUCACION PERMANENTE



**IMPRESO EN LOS TALLERES GRAFICOS DEL  
INSTITUTO GEOGRAFICO MILITAR**

Queda hecho el depósito que marca la Ley 11.723

I.S.B.N. 950-00-00-0010-5



PRESIDENTE DE LA NACION ARGENTINA

Dr. Raúl Ricardo Alfonsín

MINISTRO DE EDUCACION Y JUSTICIA

Dr. Jorge Federico Sábato

COMISION NACIONAL DE ALFABETIZACION  
FUNCIONAL Y EDUCACION PERMANENTE

PRESIDENTE

Prof. Nélica Baigorria

VOCALES

Prof. Norma Asato de Valiño

Prof. Irene Bassa Palau

Prof. Adela Castellán de Mazzotta

Prof. Arístides Roberto Chierico

Prof. Ana María Gaddi de Novillo Quiroga

Centro Nac. Información  
Documental Educativa

Pizzurno 935 Sub. Suelo  
(1120) Ciudad Autónoma de Bs. As.  
República Argentina



Observe



Forming

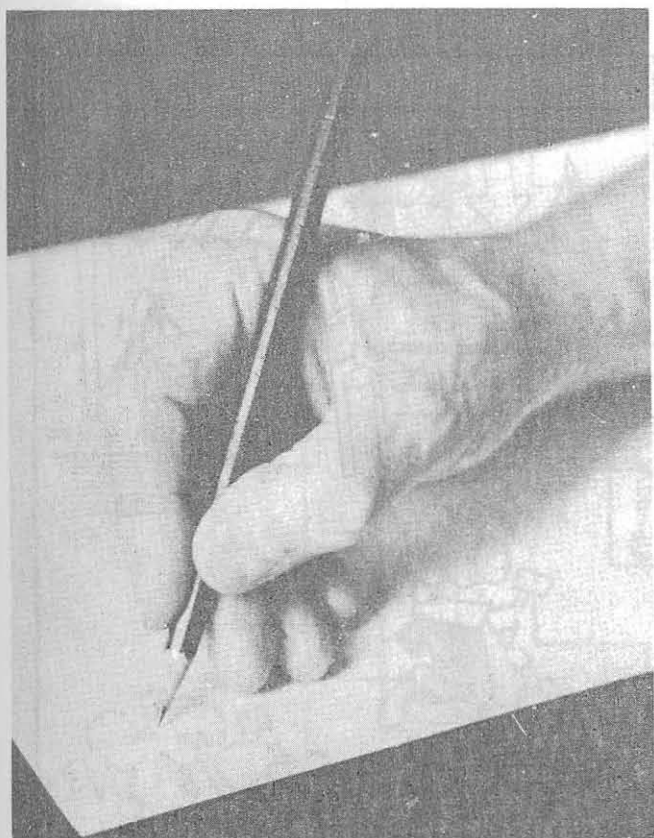
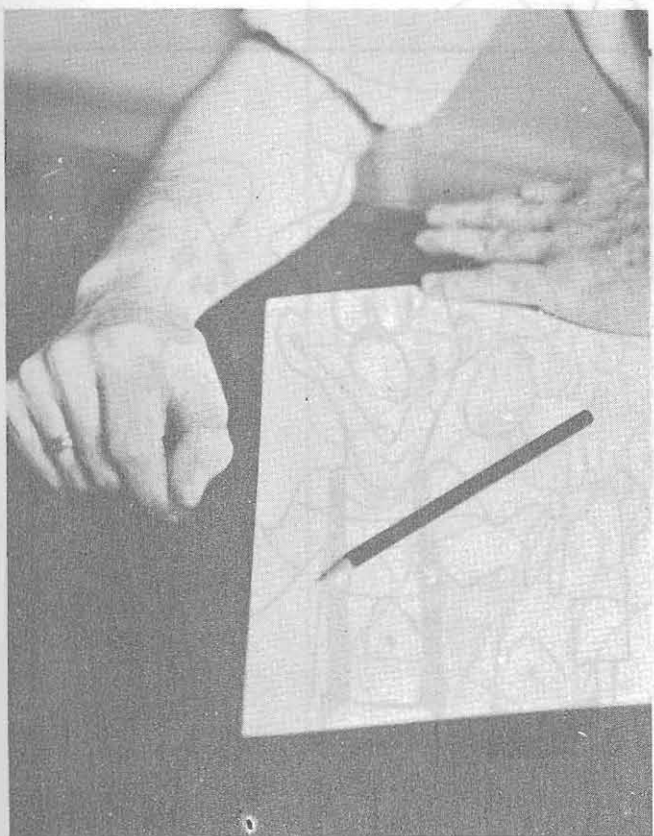
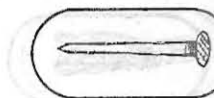

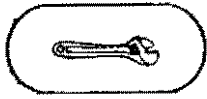

Escuche



Observe

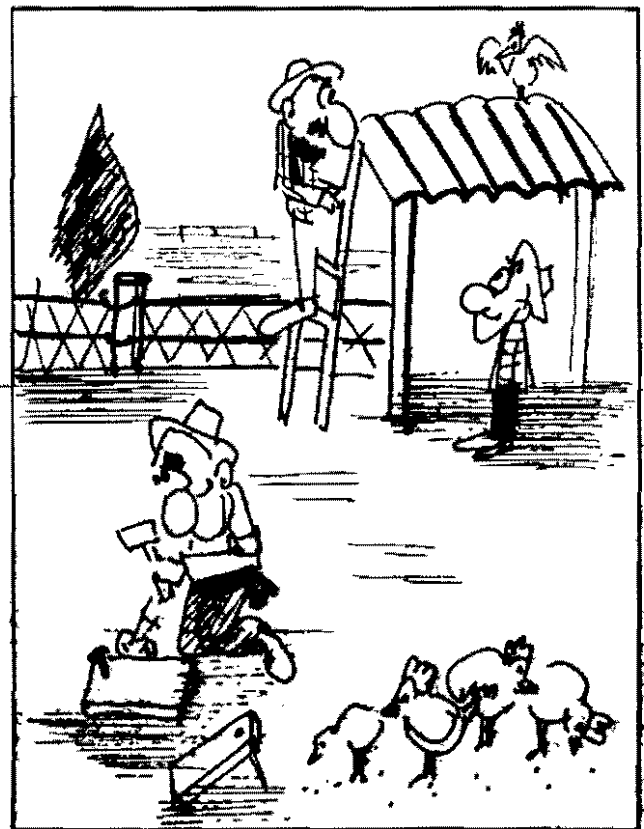



Escriba

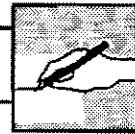
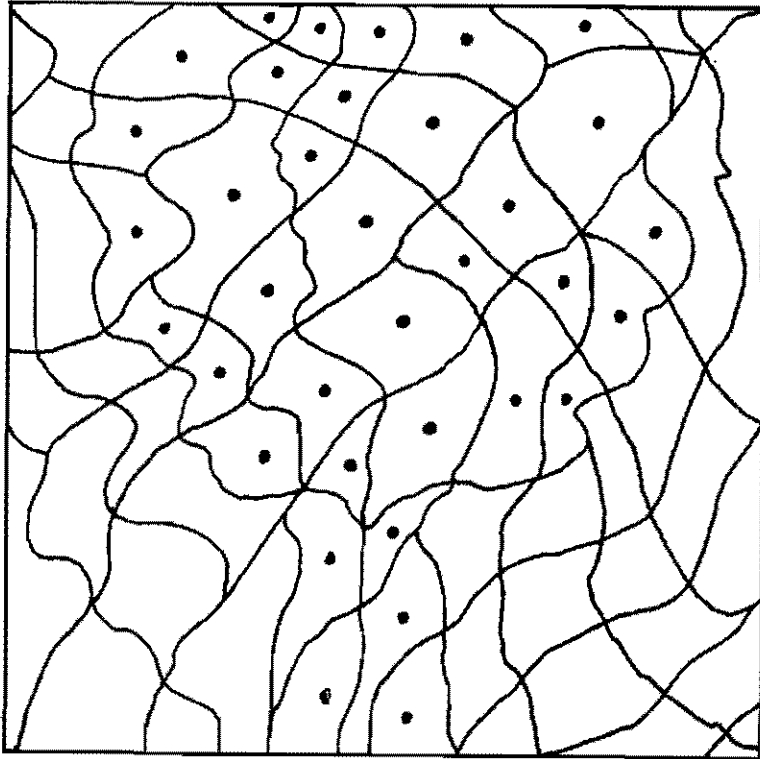

Escriba

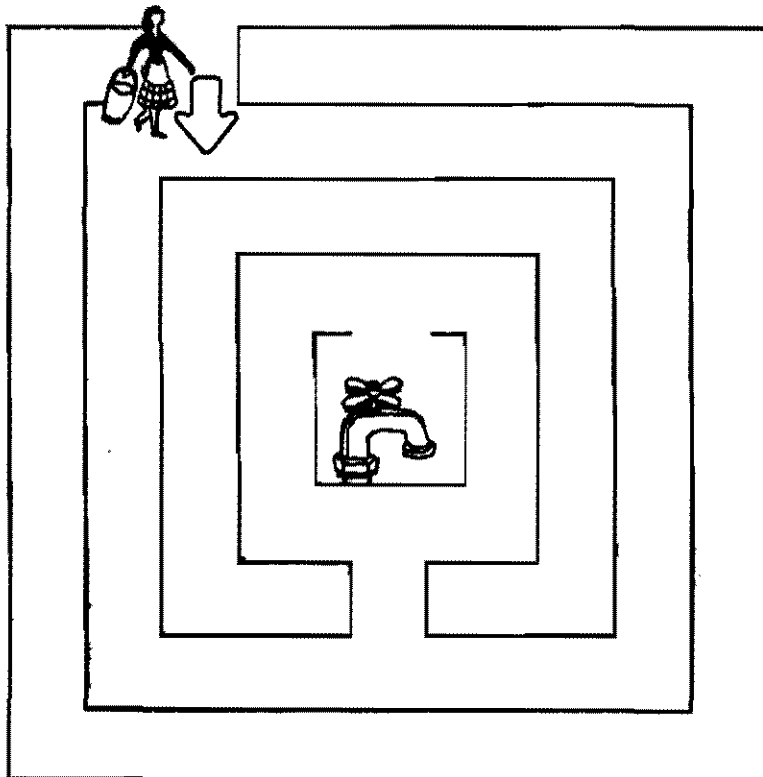

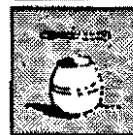

Complete

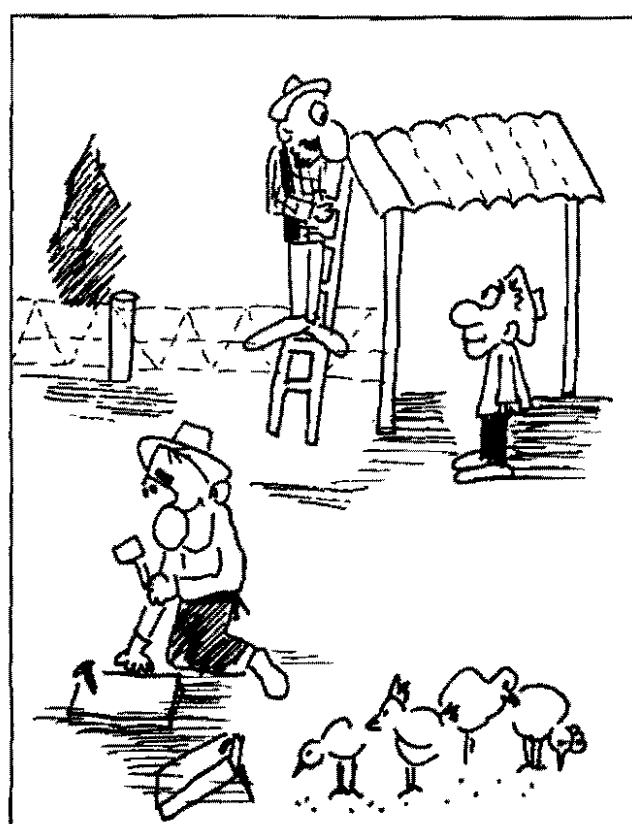
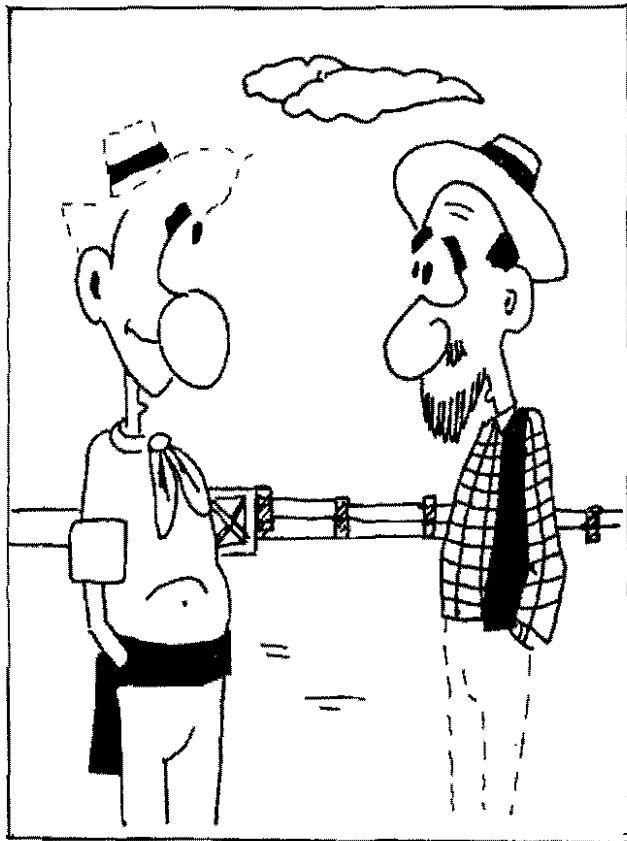





Escuche



Observe

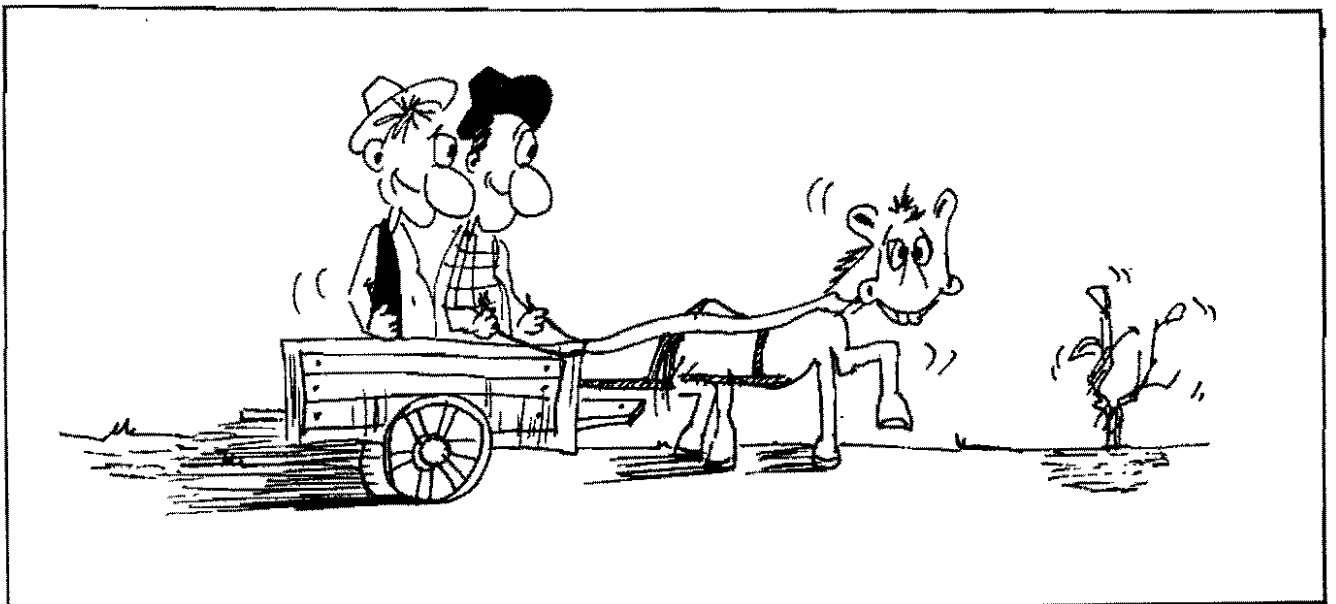
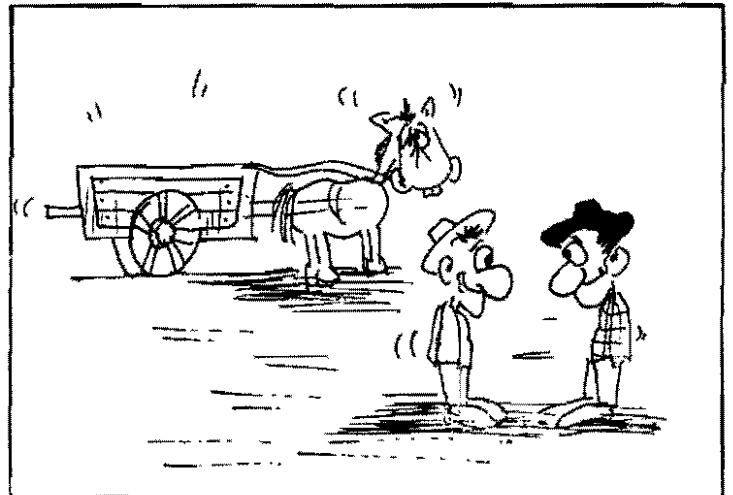
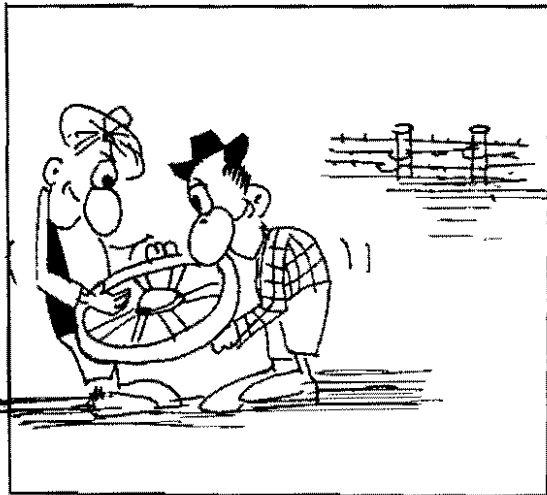
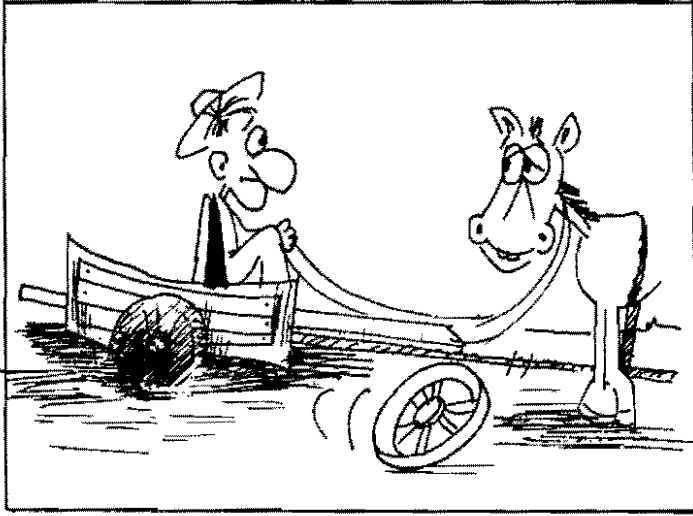

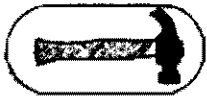

Observe

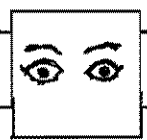
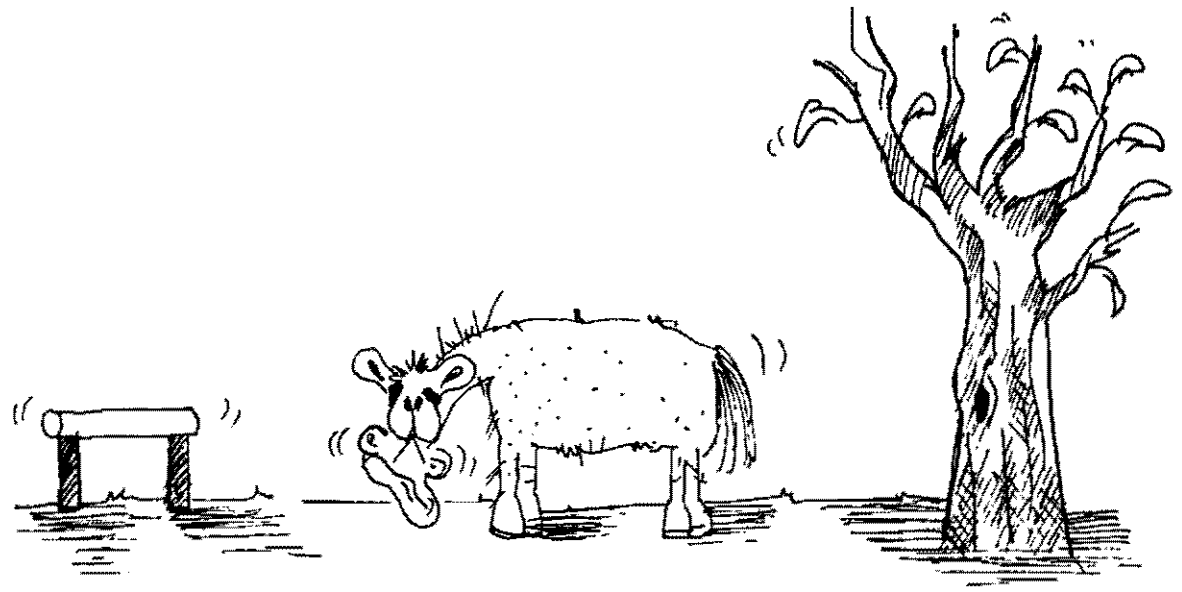

Observe

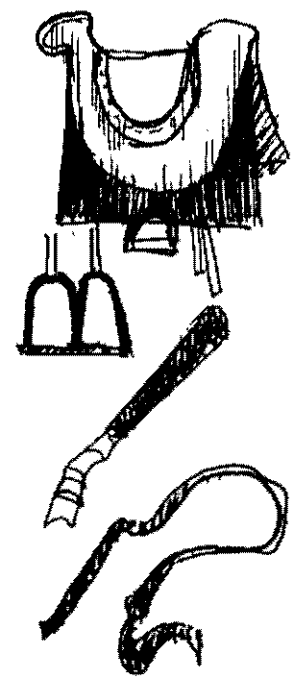
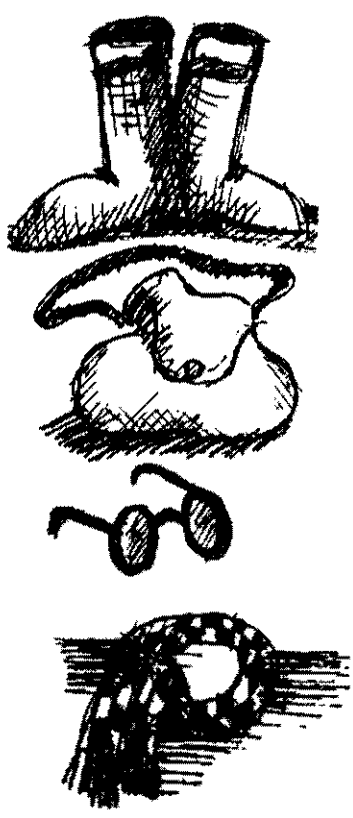



Observe

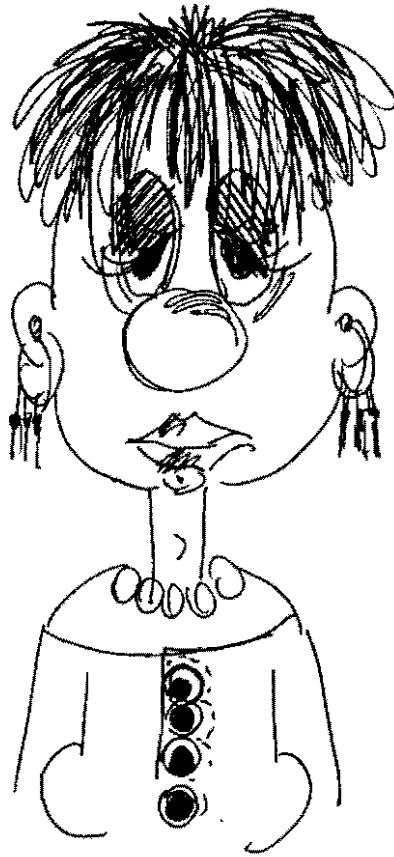
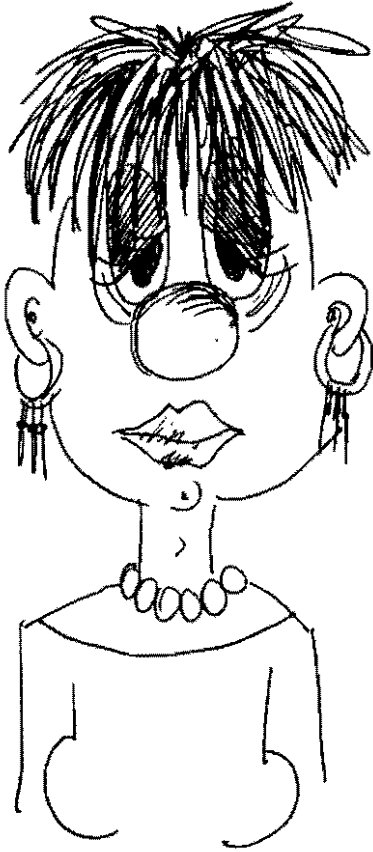
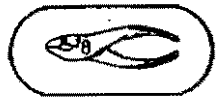

Observe

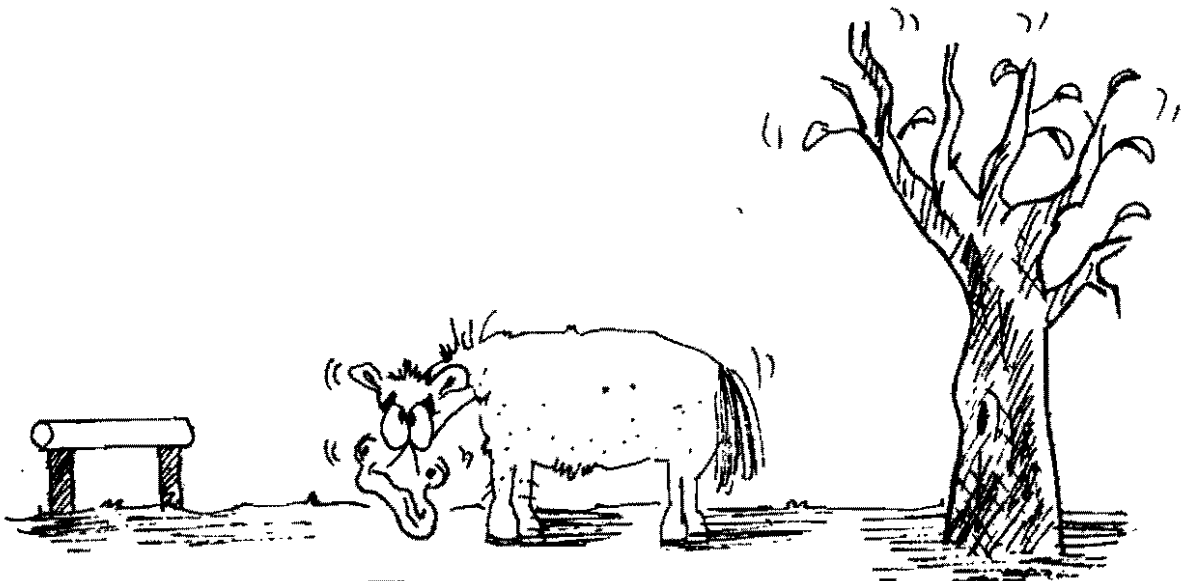



Observe

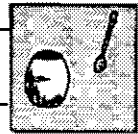
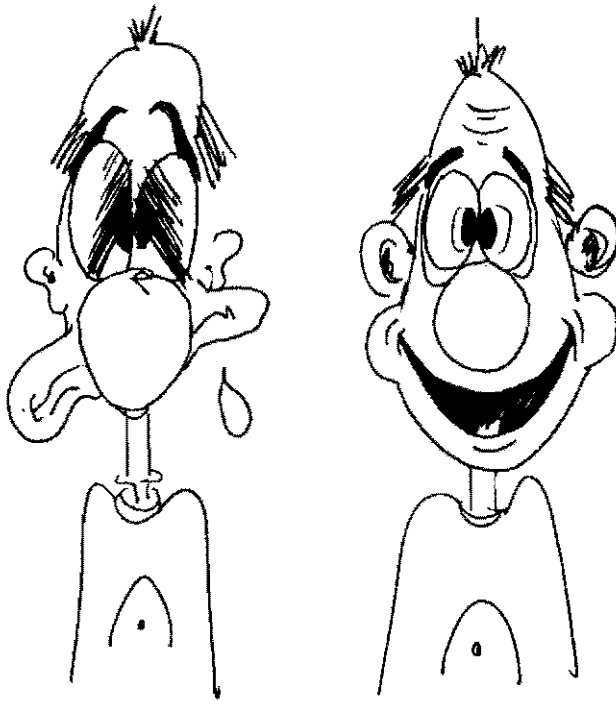

Relazione

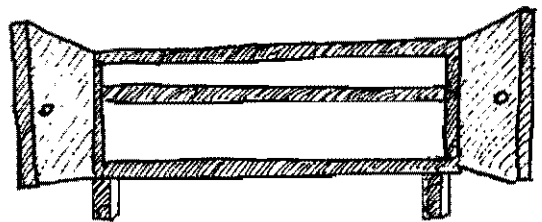
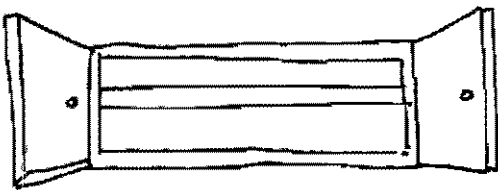



Escriba

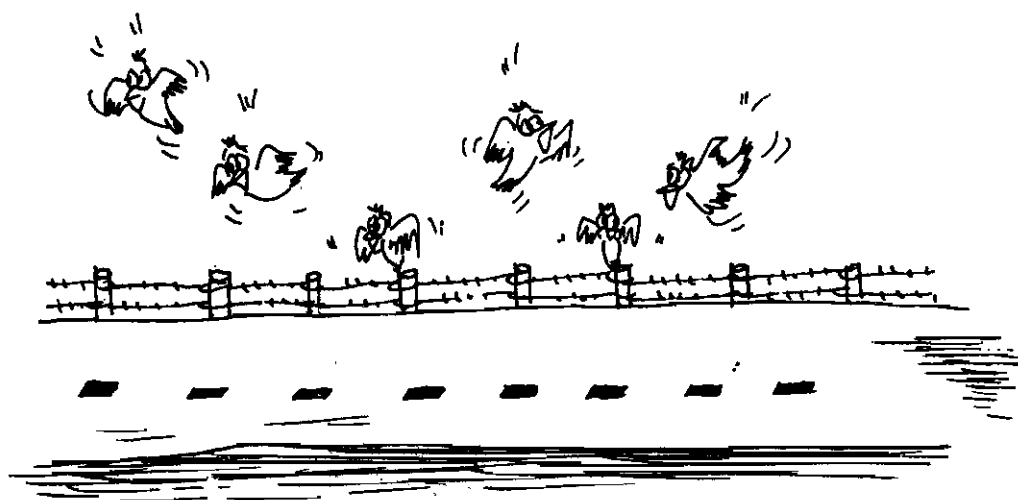
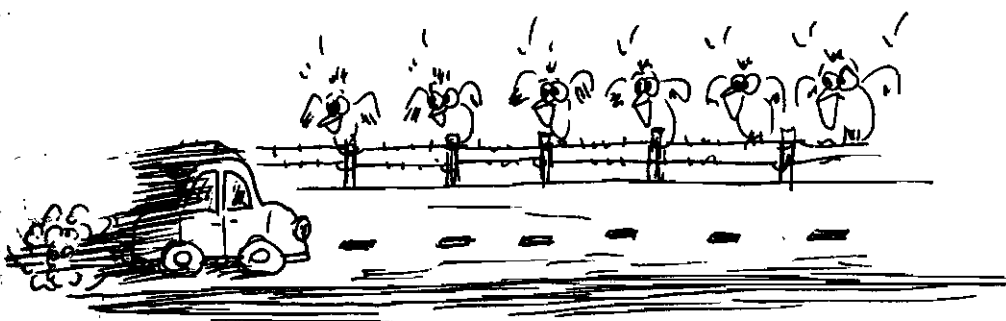
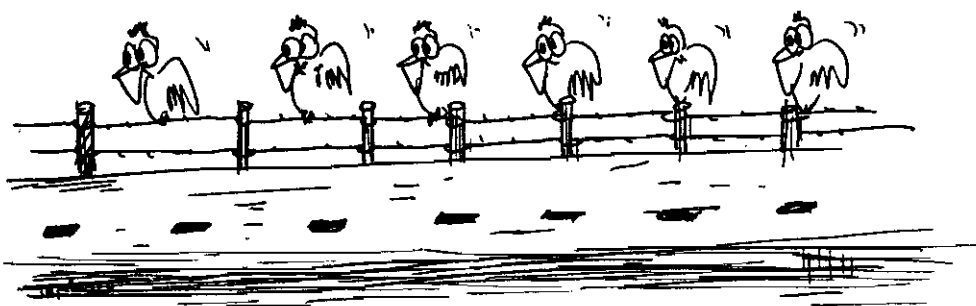

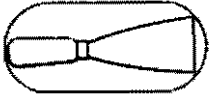

Escuche



Observe

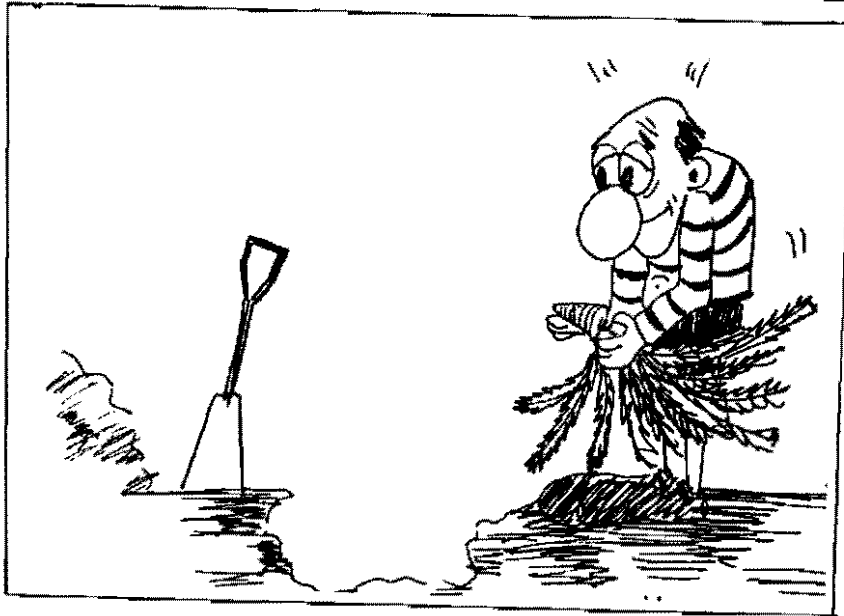
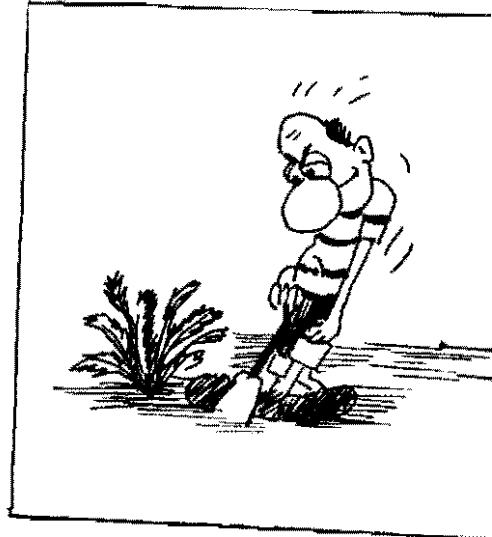



Complete.

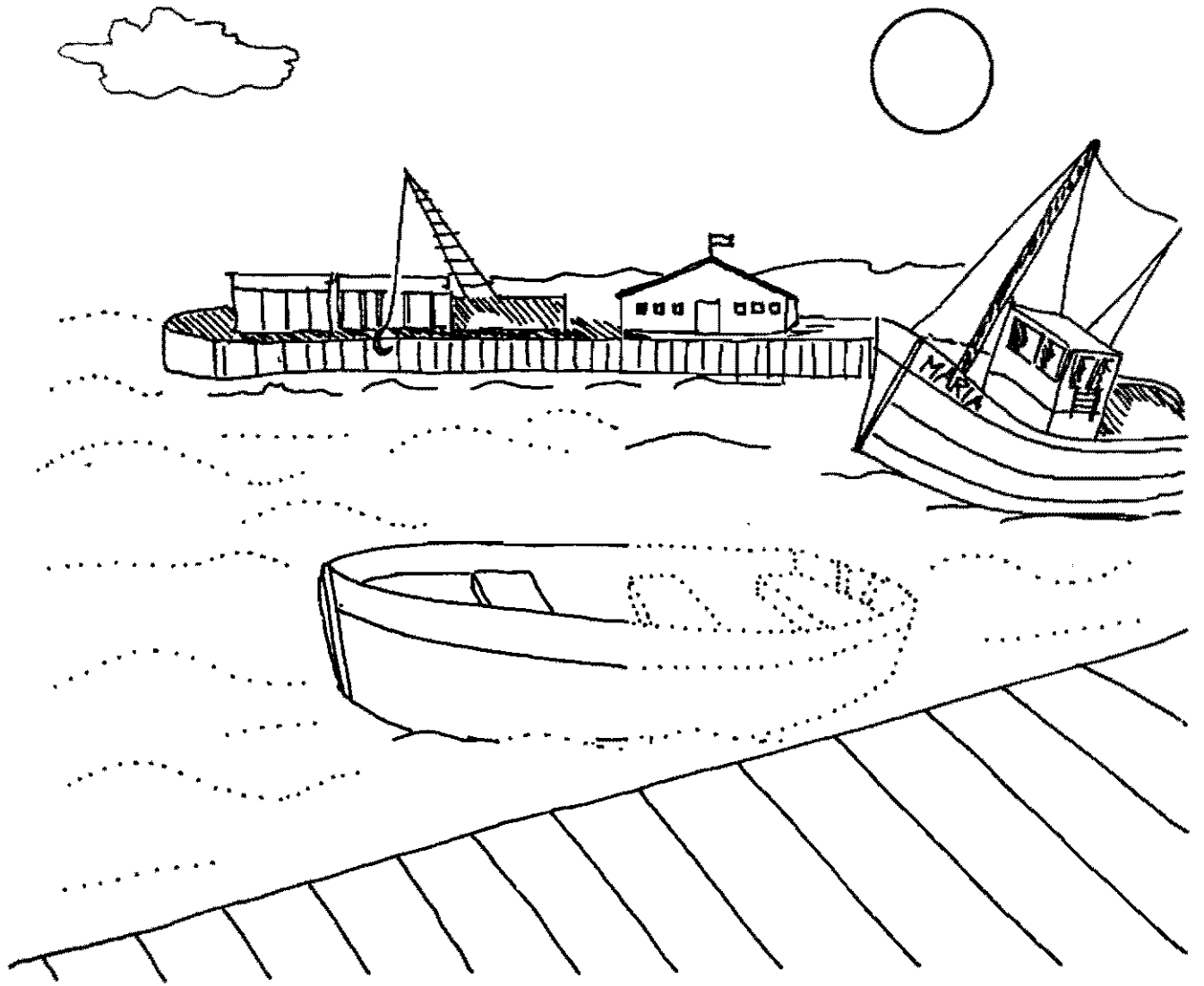

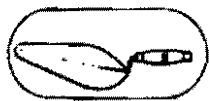

Observe



Complete



ojos

o j o s



Escuche



Escriba

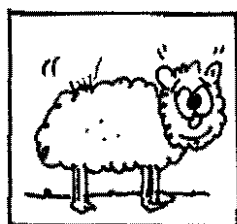

oveja

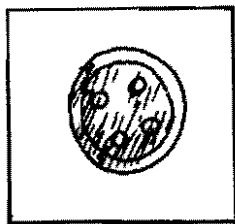

botón



uno

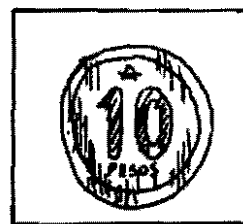

moneda





Escriba

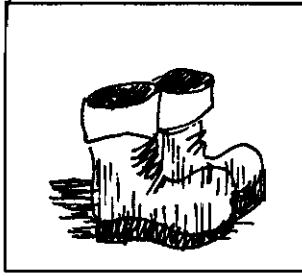
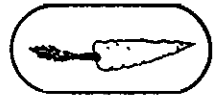

botas

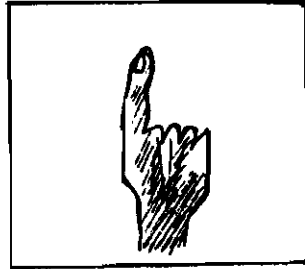

ded\_

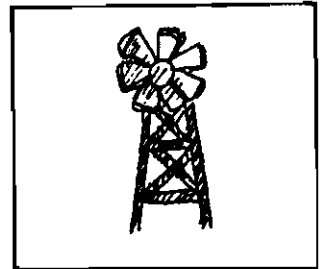

m\_lin\_



Olga



\_mar

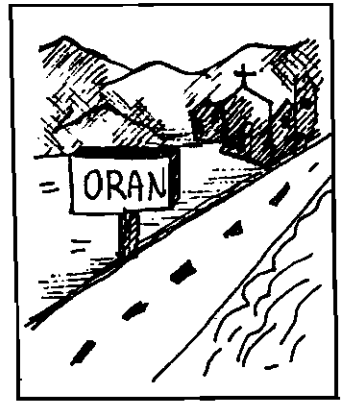

\_rán



Escuche

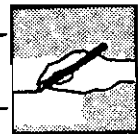

Escriba

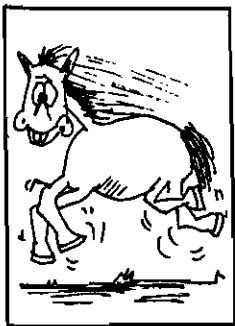

gal\_pe



b\_mb\_

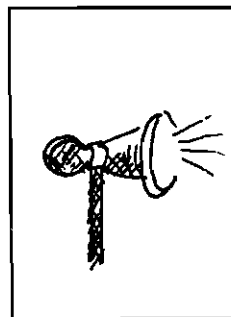

b\_cina

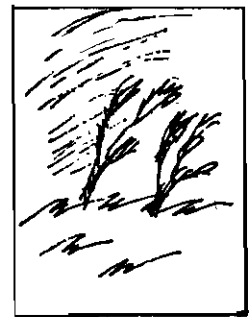

vient\_



Escuche



Observe

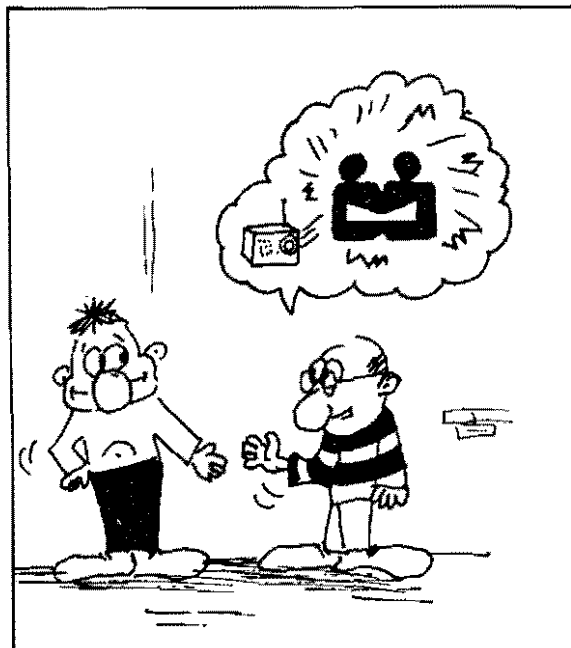



Observe



Escriba

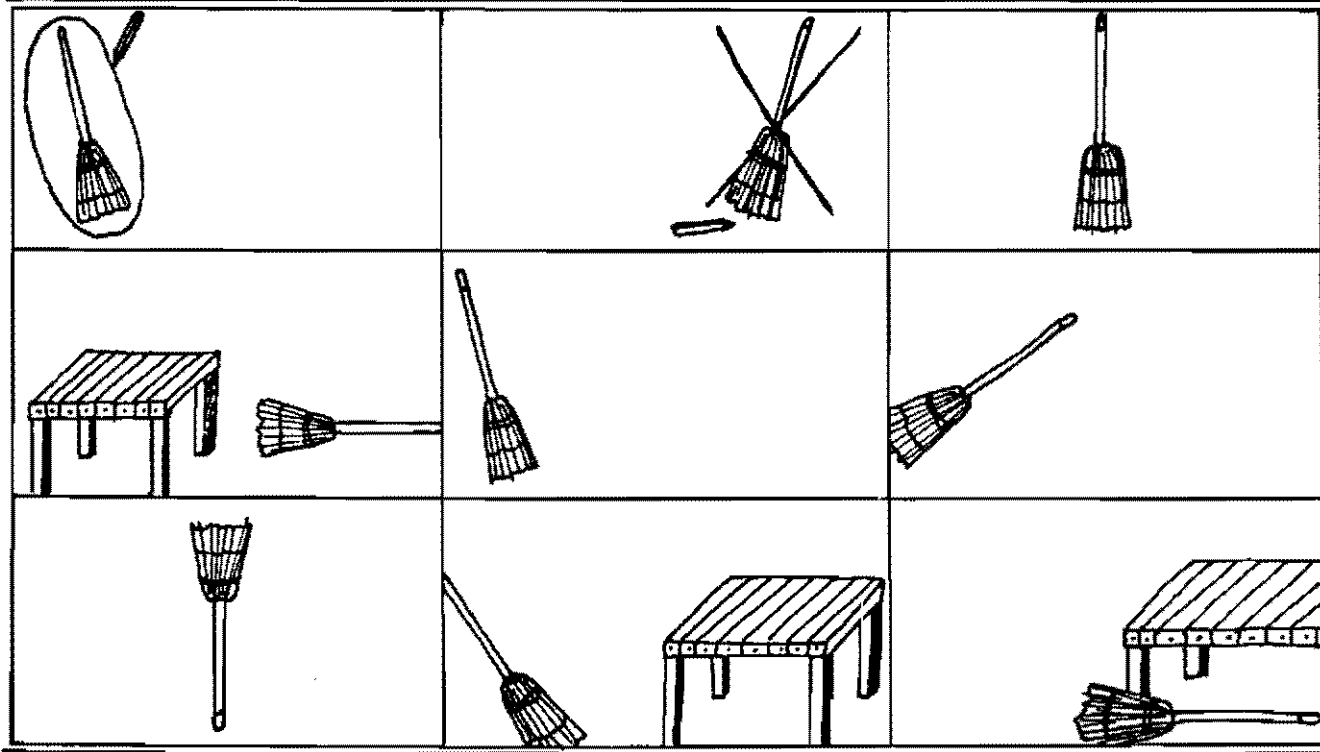

Complete

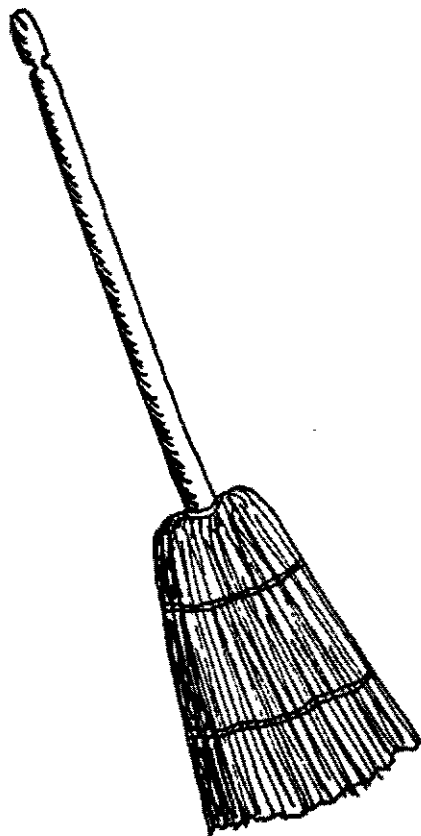

escoba

escoba

e	e	e	e	e
e	e	e	—	—
E	E	E	—	—



Escuche



Observe

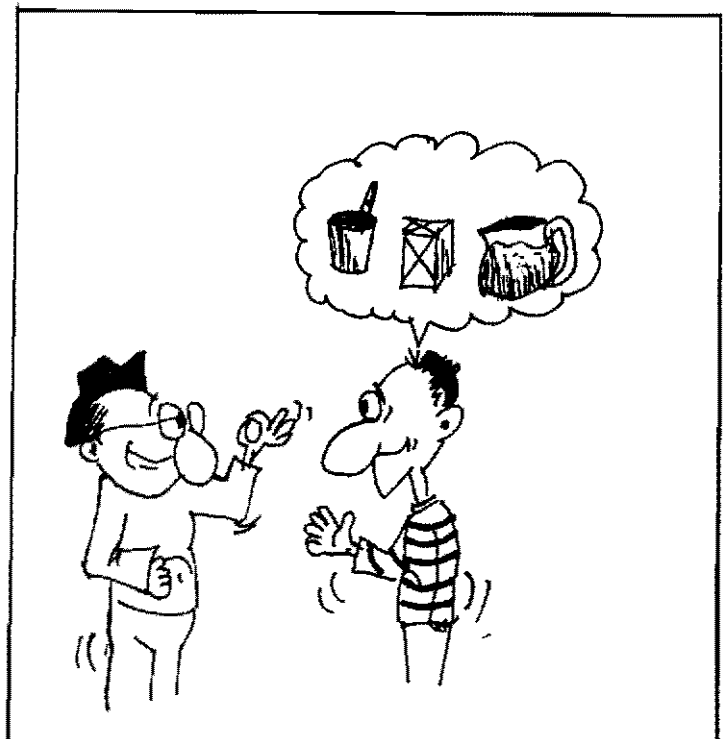
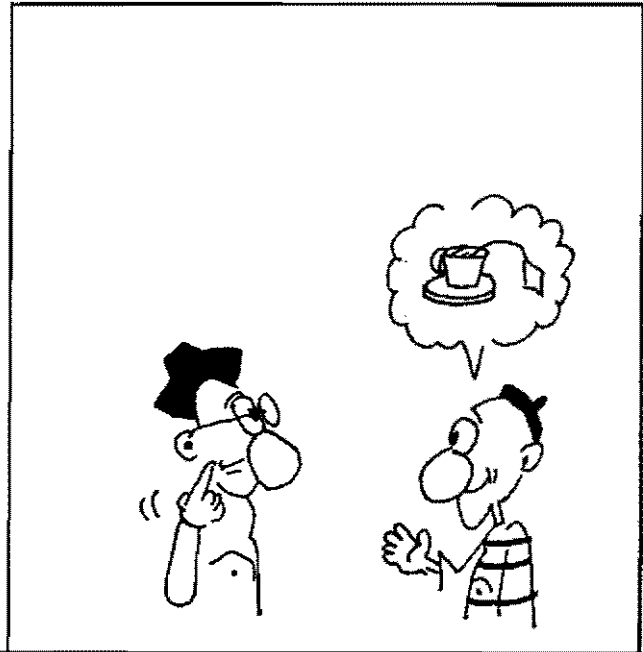



Escuche

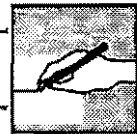
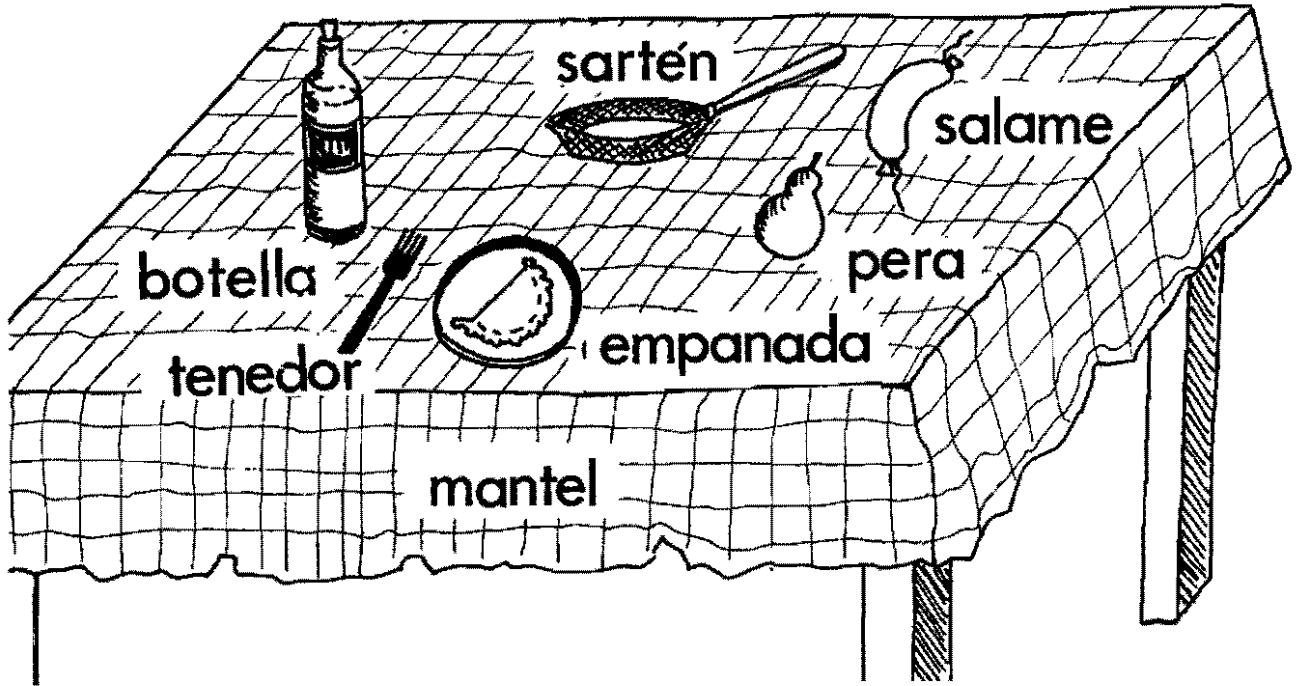

Escriba

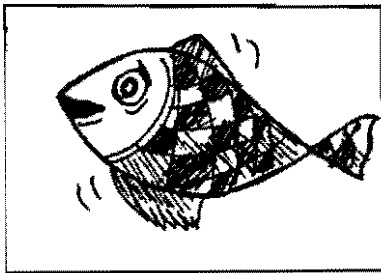

pescado

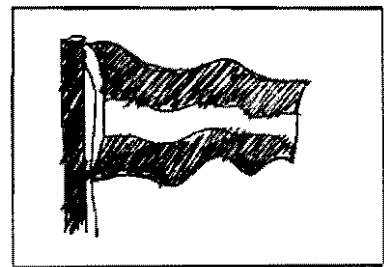

band\_ ra

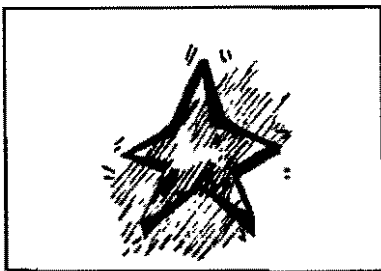

\_str\_ lla



p\_ rro



Observe



Escriba



Estela

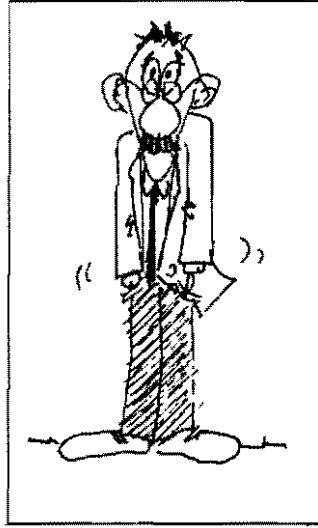

\_rnesto

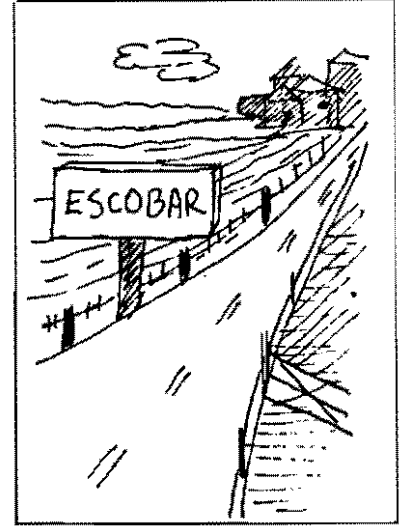

\_scobar

E

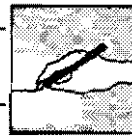

Escriba

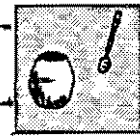

Relacione

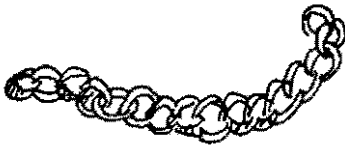

\_spada



cad\_na

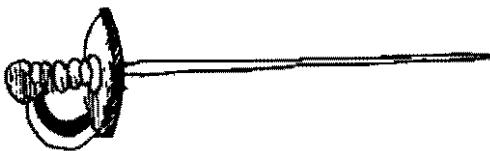

mat\_



Observe



Escuche

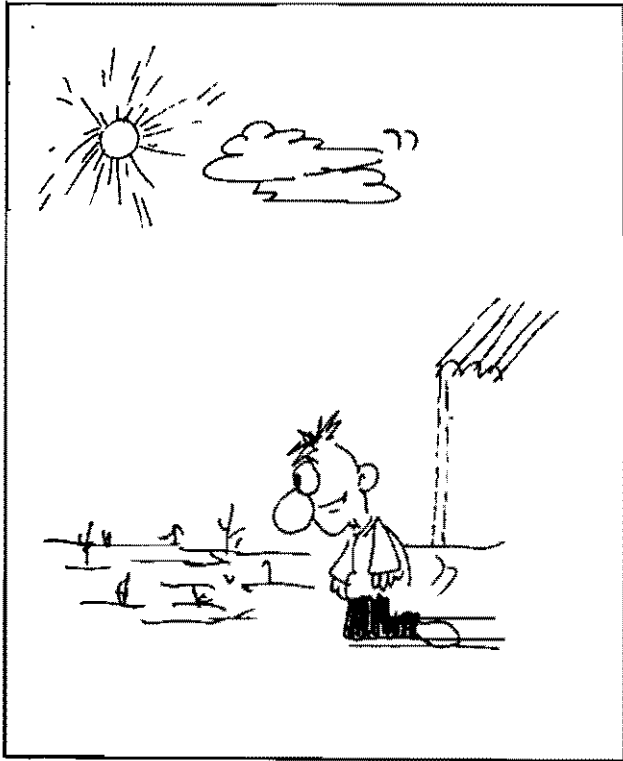



Compruebe

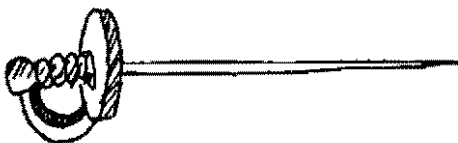
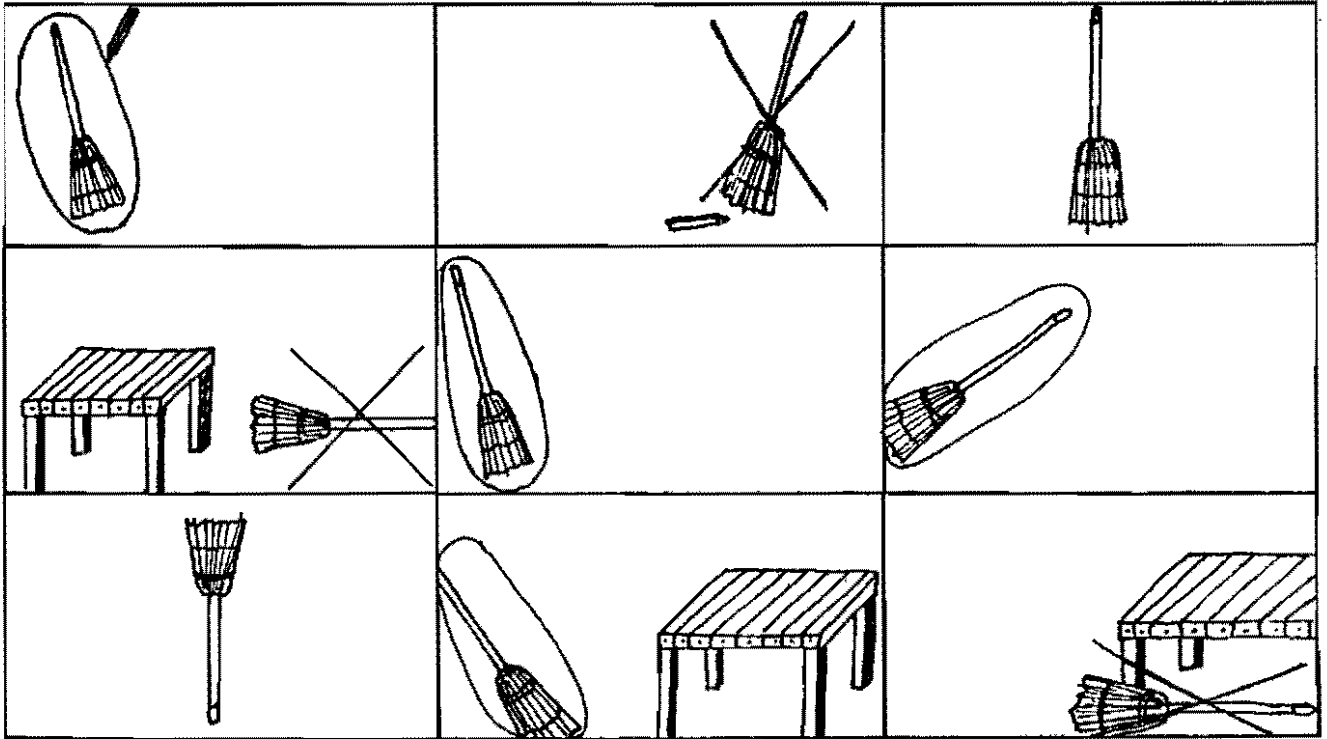

espada

cadena

mate





Observe

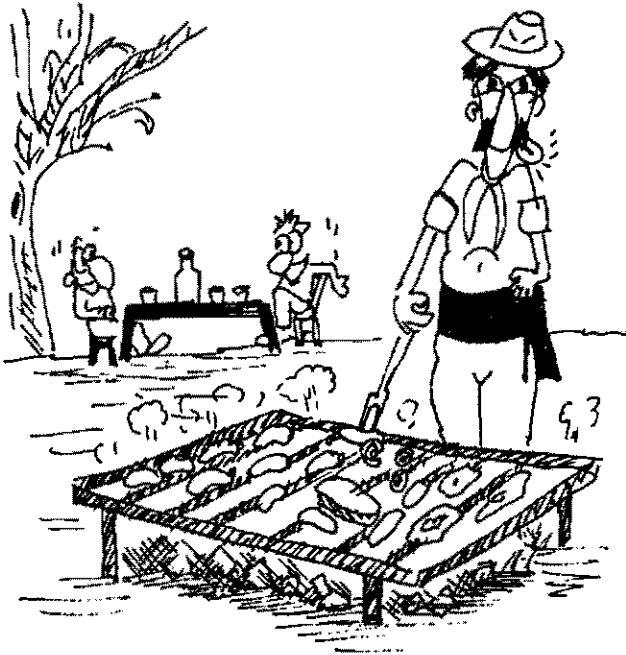

asado

a A

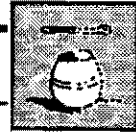

Complete

a d j c i \_

A A A A / \_

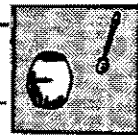

Relacione

Andrés

pollo

vaca

huevo

Ana

papas

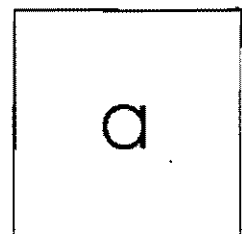
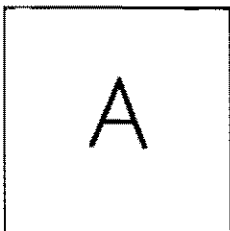



Escuche





Escriba

L\_ c\_rne de v\_c\_ es ric\_

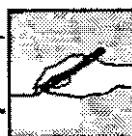
L\_ ens\_l\_d\_ est\_ muy s\_l\_d\_

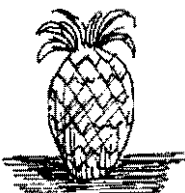
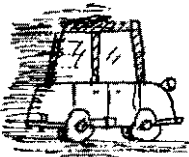

Escriba

			
			
			
		A	



Escuche



Observe

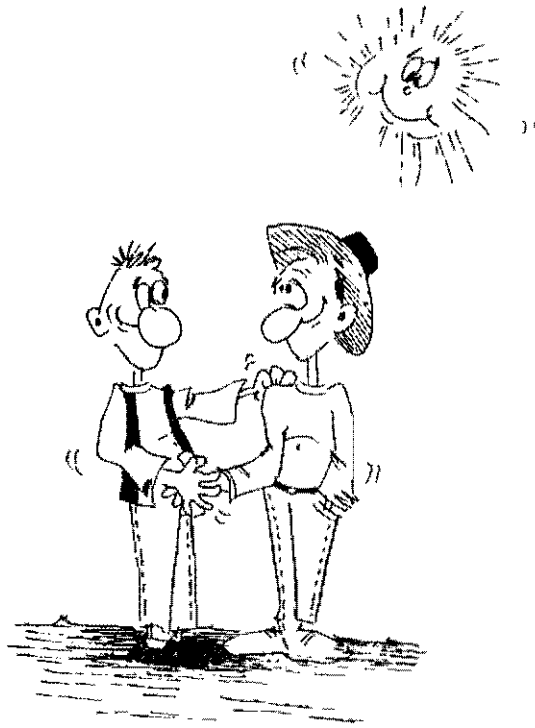
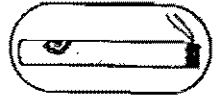

Compruebe

A

Andrés  
pollo  
vaca  
huevo  
Ana  
papas

a

a			
	a		
		a	
	A	A	

La carne de vaca es muy rica  
La ensalada está muy salada



Observe



Comple

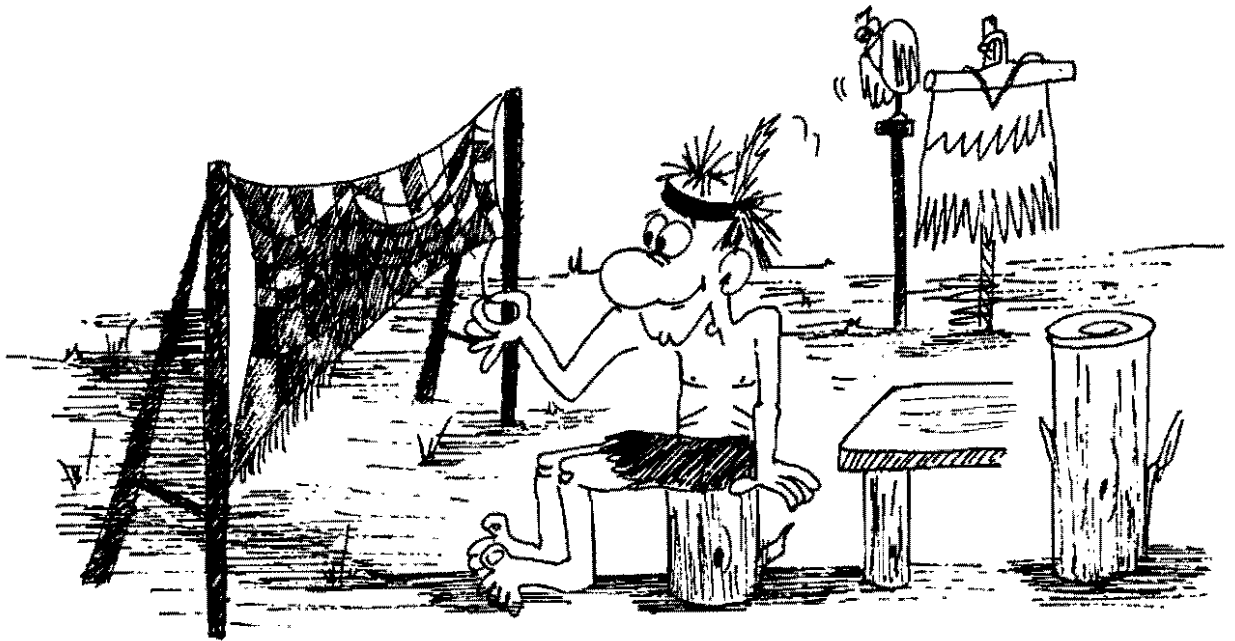

indio

indio



Comple

i     i     i     i     -     -  
 |     |     |     |     -     -  
 |     |     |     |     -     -



Escuche



Observe



Escriba



# La Virgen de Itatí, patrona de los correntinos, tiene una nueva capilla.

Nada más que una casualidad.  
Una simple casualidad, pero  
sirve para que arranquen  
estas herraduras desde  
tiempo

Amigo esta breve investigación  
marcará, desde segundo  
lucó el nuevo, lo vimos ar-  
mitos antes de la re-  
my presu-

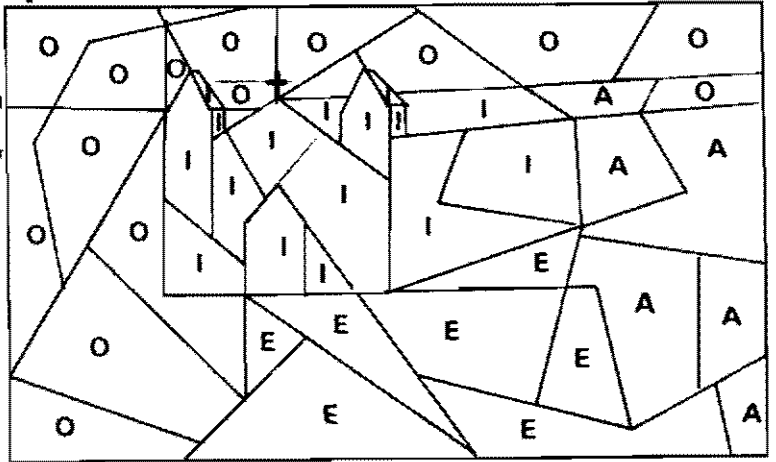

Escriba



\_nocencio e \_nés visitan las  
Cataratas del \_guazú



Escuche



Escriba

\_rma

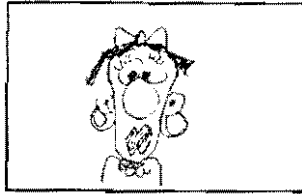

\_ndustria

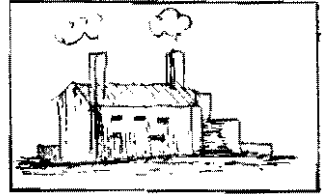

\_sla

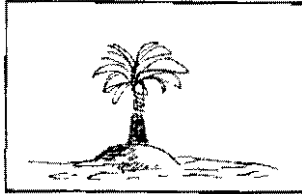

\_gnacio

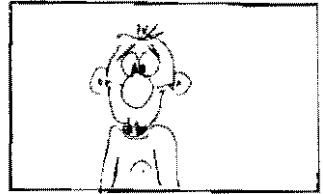

\_dea



\_tuzaingó

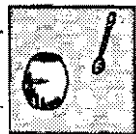

Relacione

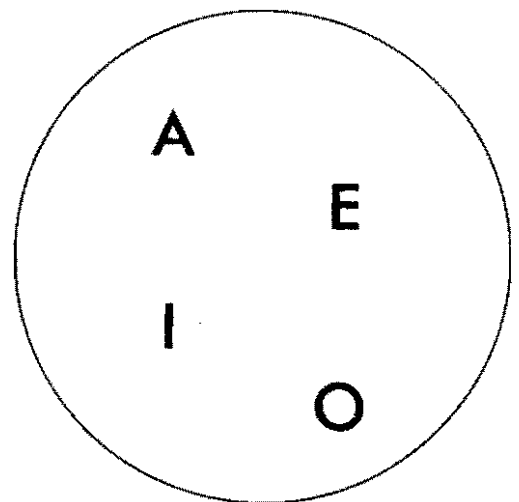
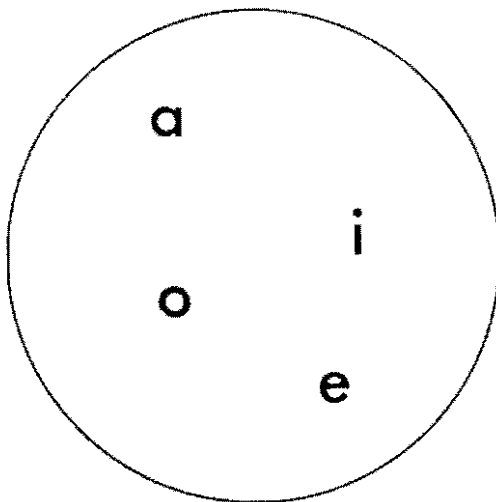



Escuche



Escriba

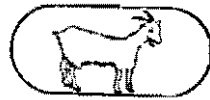

pir

nd\_s

z\_rr



r\_n



Compruebe

Irma



industria

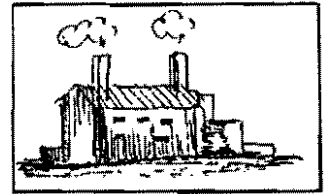

isla

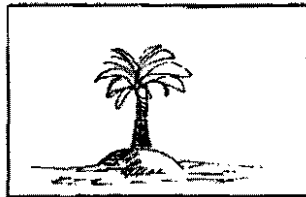

Ignacio

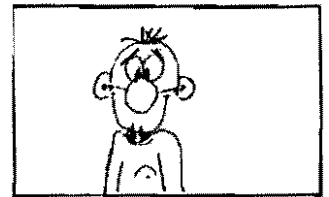

idea



Ituzaingó

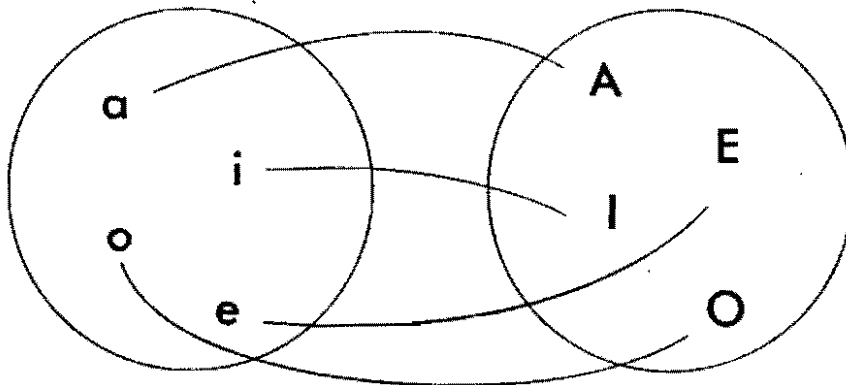
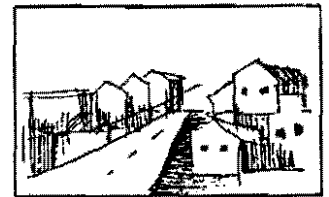

araña



pájaro



zorro

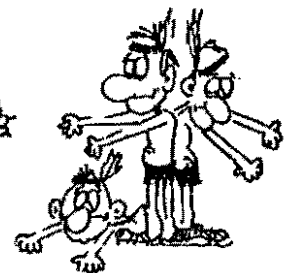

indios





Observe



Complete



Escriba

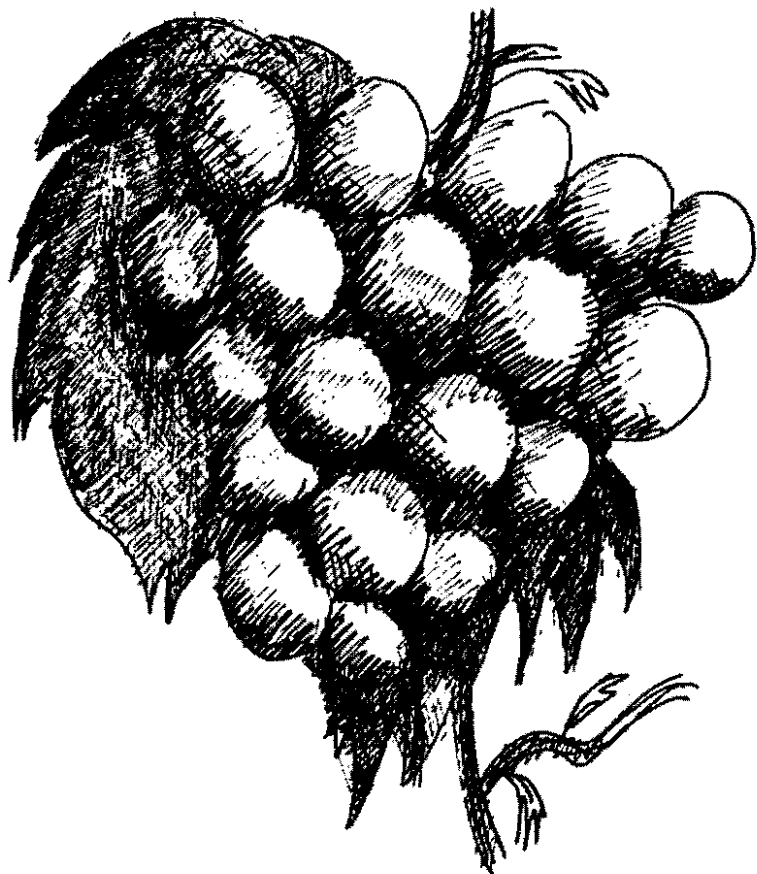

uva

uva

u U

u u u u u u

U U U U U U



Escuche



Escriba

 _rsula	 _ña	 _niforme	U
 _tiles	 _bre	 _baldo	U

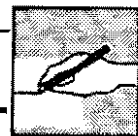

Escriba



Tu ayuda a la comunidad es muy útil.







Escuche



Compruebe

 Ursula	 uña	 uniforme	u
 útiles	 ubre	 Ubaldo	U

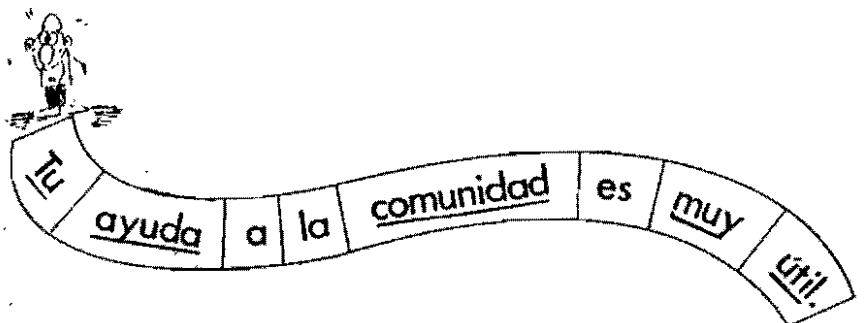



Escuche



Observe



Amarse  
el uno  
al otro  
a través  
de la  
comunicación.





Escriba

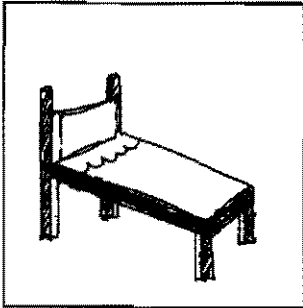

c \_ m \_

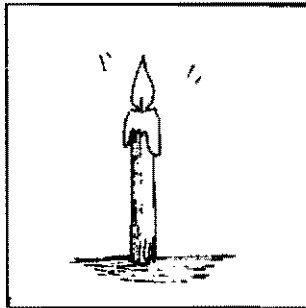

v \_ l \_

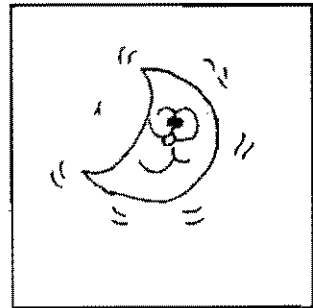

l \_ n \_

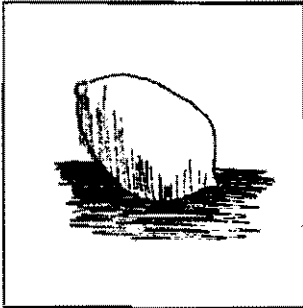

l \_ m \_ n

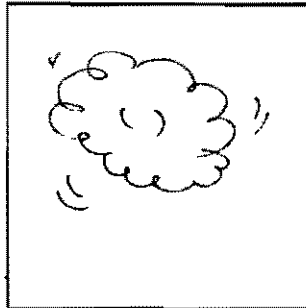

n \_ b \_

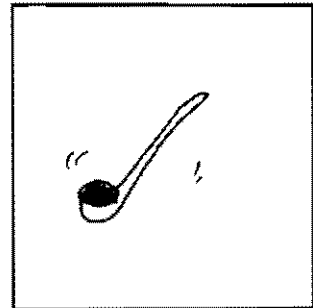

c \_ ch \_ r \_ n



Relacione



Elena - pipa



camisa - Alberto



Escriba

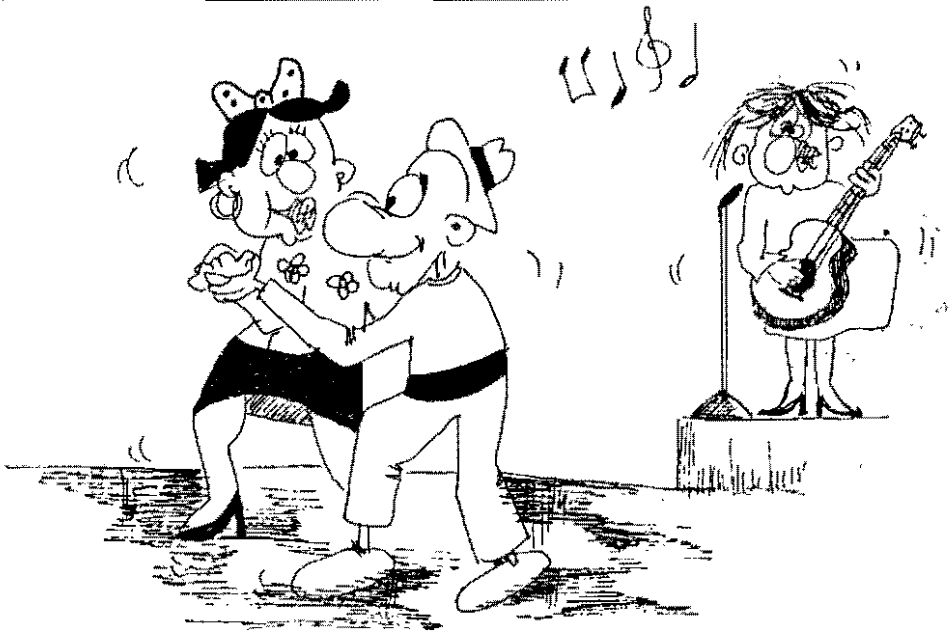

T\_r\_s\_t c\_nt' \_n l\_nd\_ ch\_m\_m'.

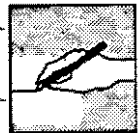

Escriba

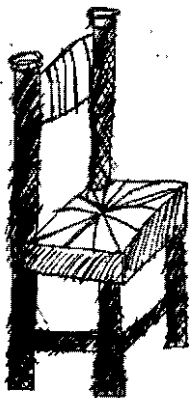

silla

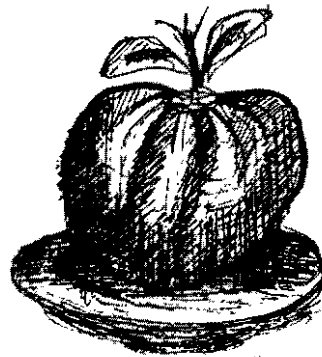

tomate

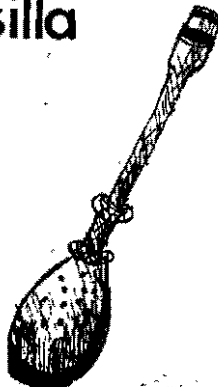

bombilla

atredif, oraco

oaiq, oraid

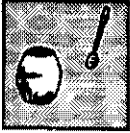

Relacione

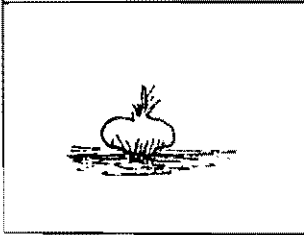
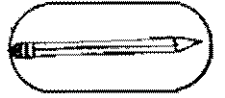

OSO

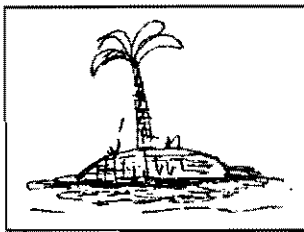

ajo



isla

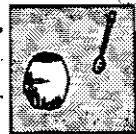

Relacione

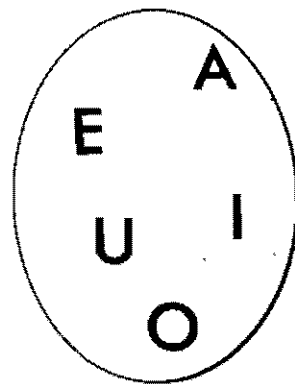
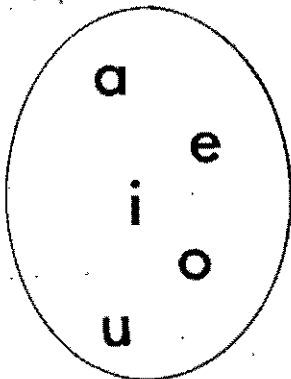



Compruebe

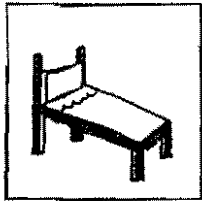

cama

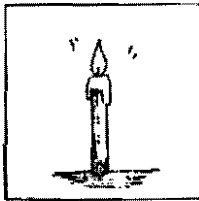

vela

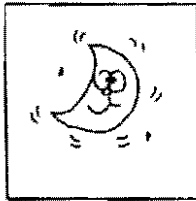

luna

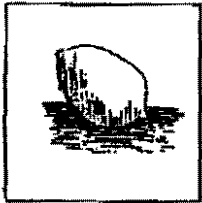

limón

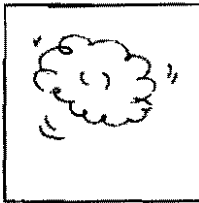

nube

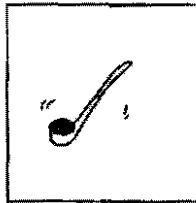

cucharón



Elena - pipa



camisa - Alberto

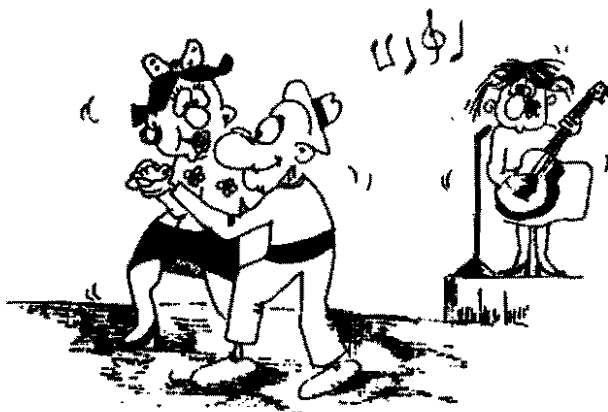

Teresita cantó un lindo chamamé.

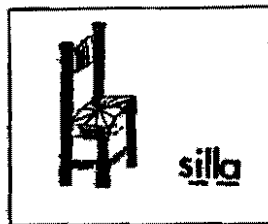

silla

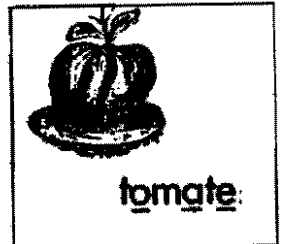

tomate



bombilla



oso



ajo



isla

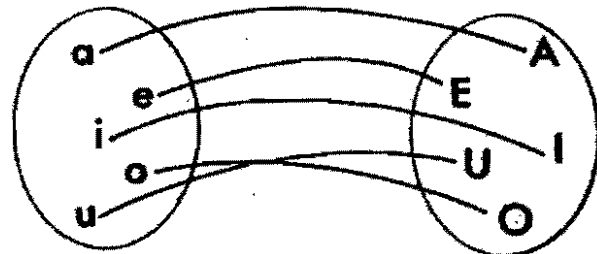





Observe



Esauche

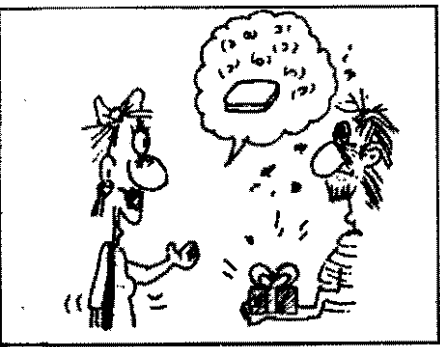
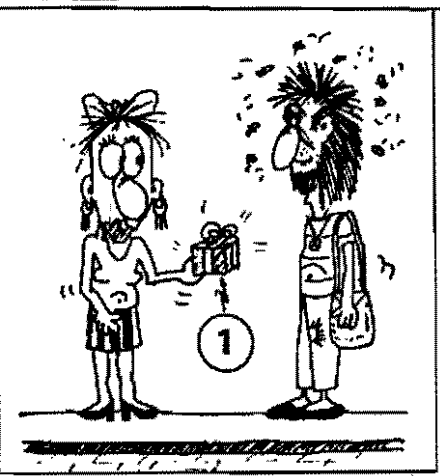

Observe

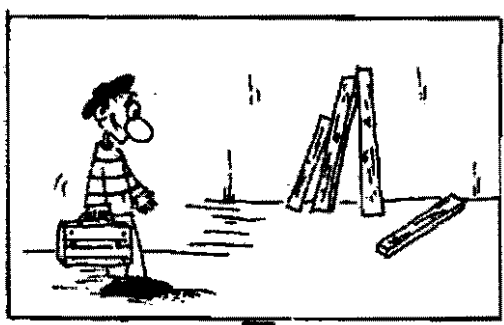

1

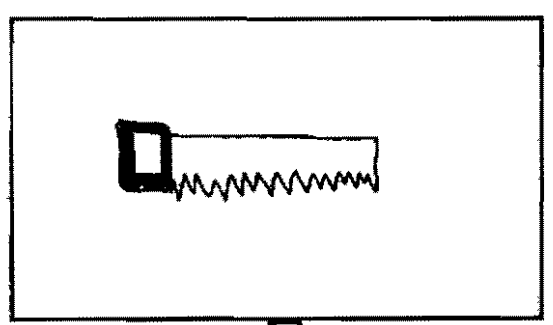

1



Complete





Escuche



Observe

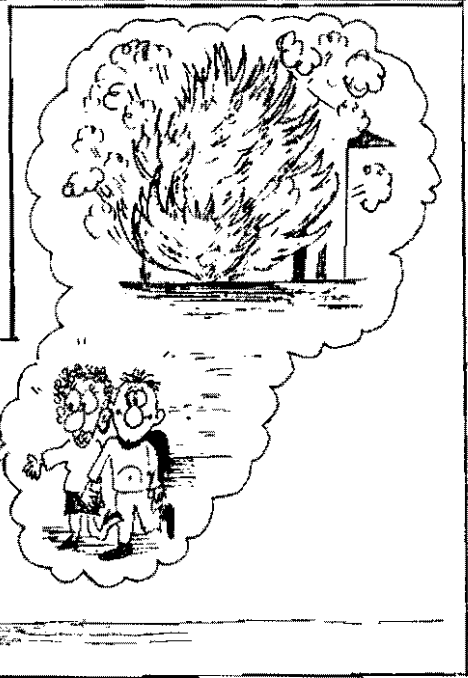
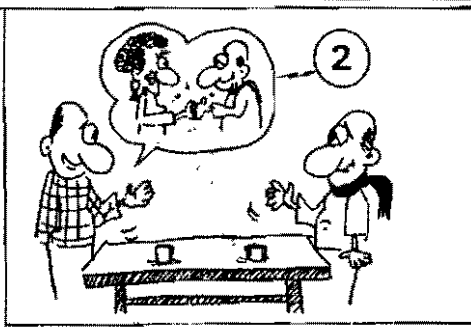

Observe



1

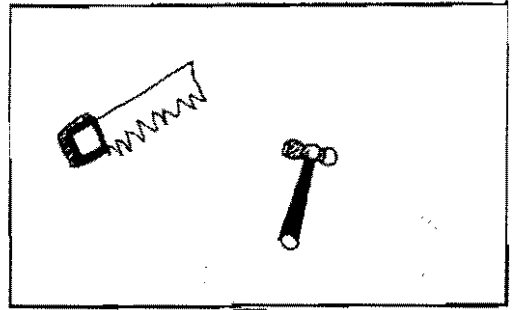

2



Escriba

2 2 2 2 2 2 2 2



Cuenta



Escriba

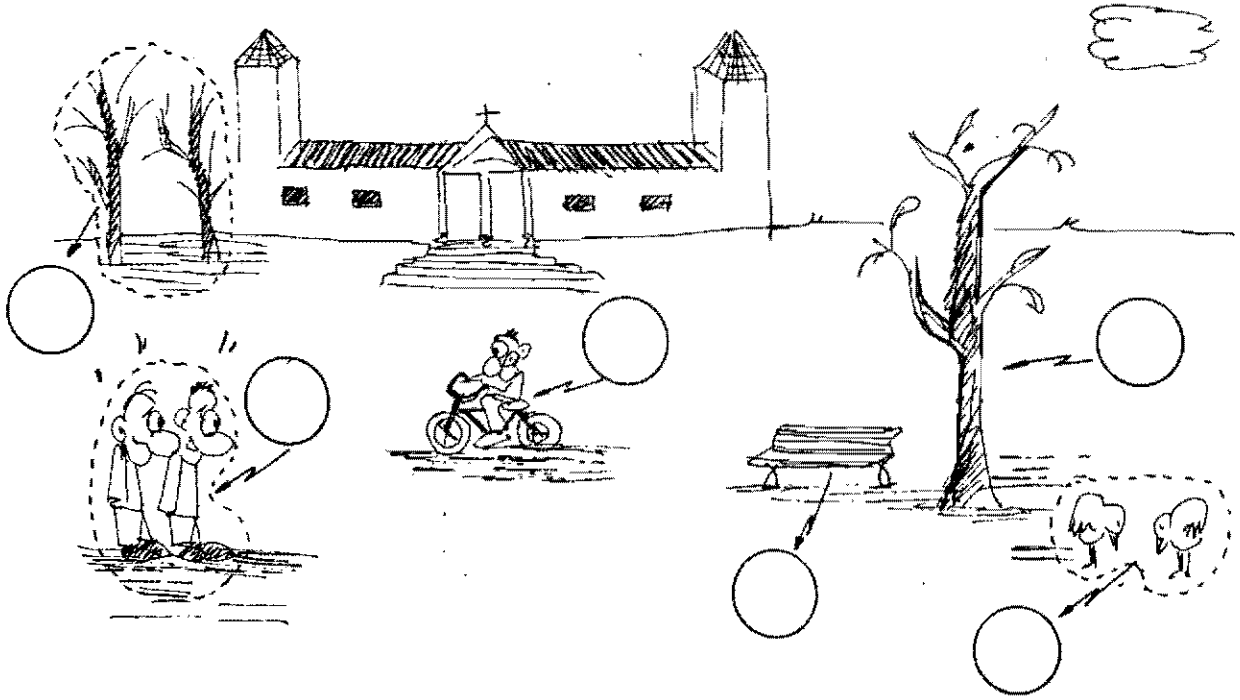

Cuenta

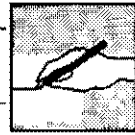

Escriba

mesa       yo       veo       uno   
 más       dos       el       sol

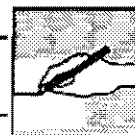

Escriba

1 1 1 1 1 1 1 1 1 1 1  
 2 2 2 2 2 2 2 2 2 2 2  
 1 2 1 1 2 2 1 2 1 2



Cuenta



Escrib

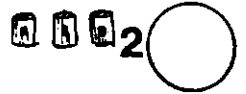
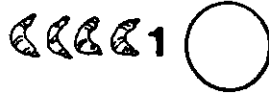
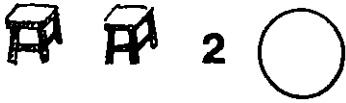
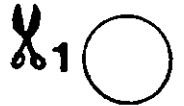
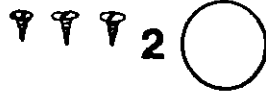

Escuche

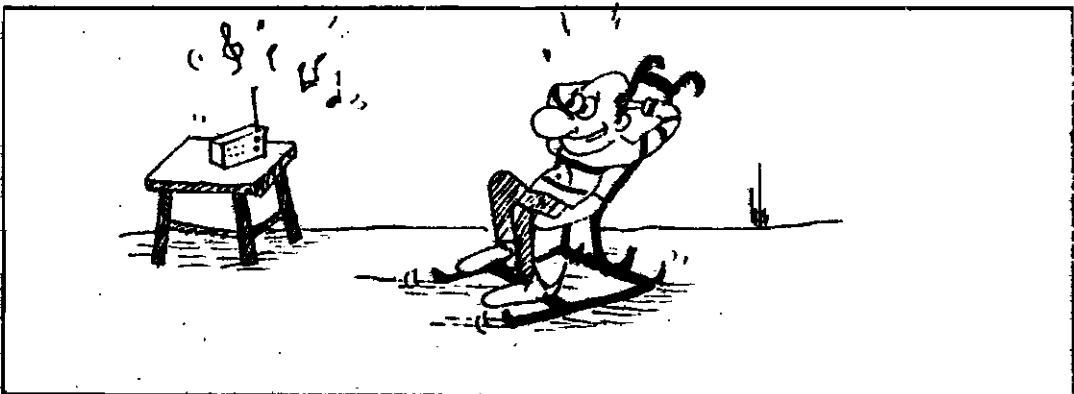
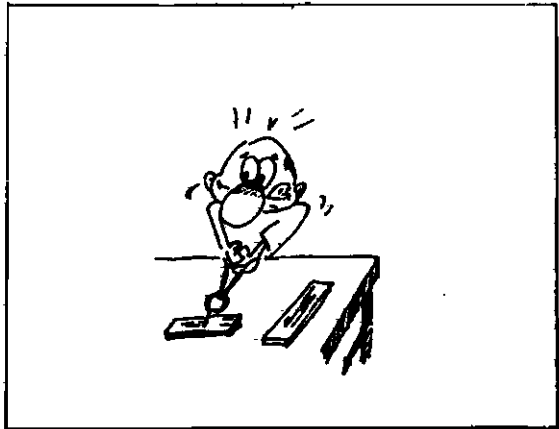
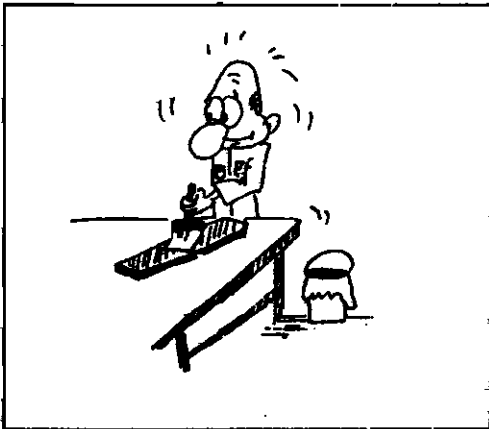
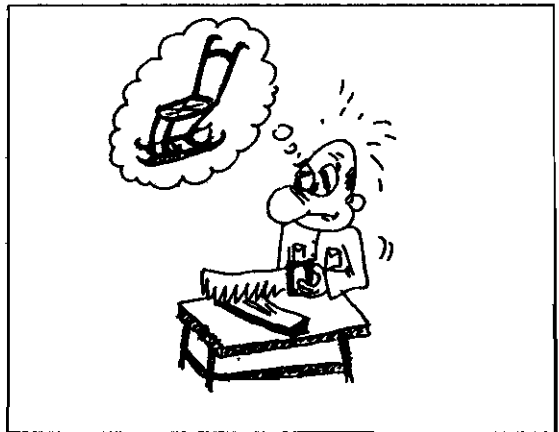
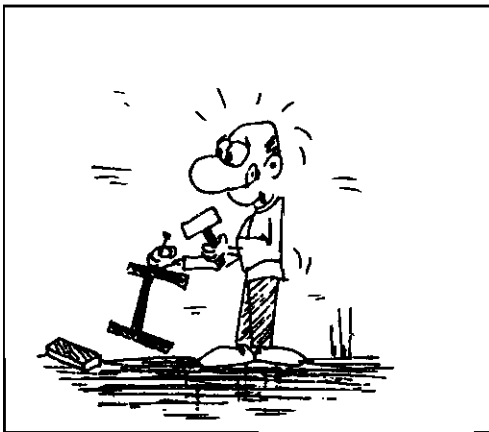



Compruebe

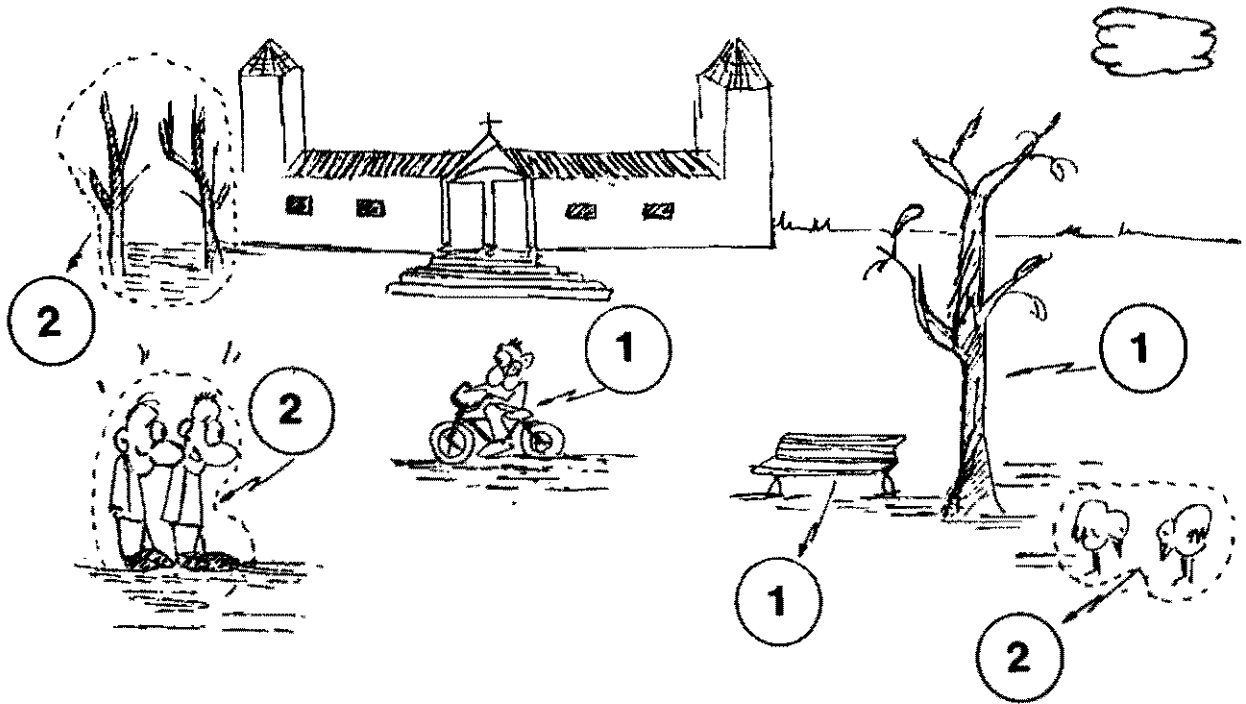





Compruebe

mesa (2)    yo (1)    veo (2)    uno (2)  
 más (1)    dos (1)    el (1)    sol (1)

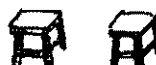

Compruebe

 1 (X)     
  2 (X)     
  1 (1)  
 2 (2)     
  1 (X)     
  2 (X)

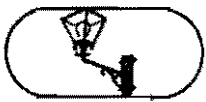

Escuche



Observe

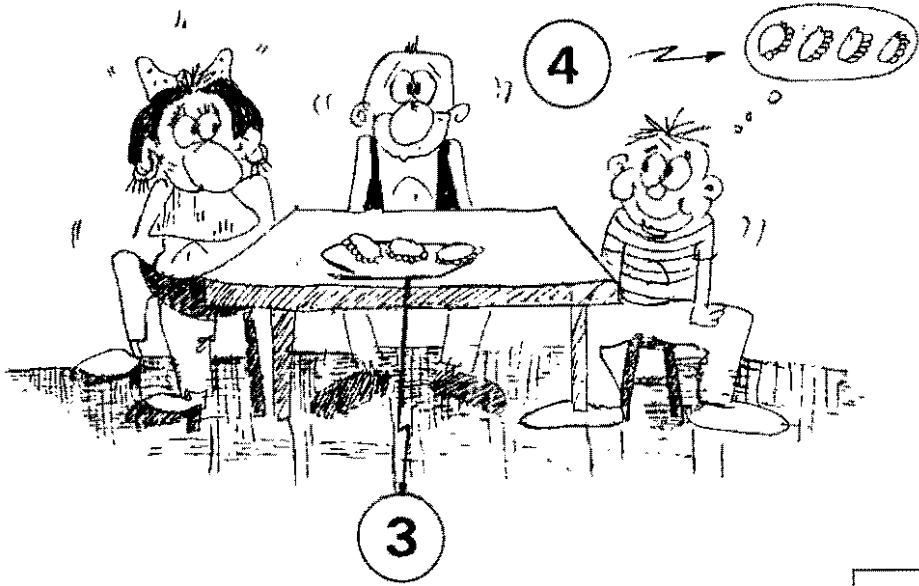

Observe

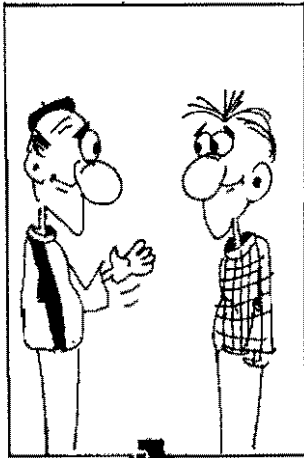

2



1



3



Complete

3 3 3 3 3 3 3 3 3 3 3 3 3

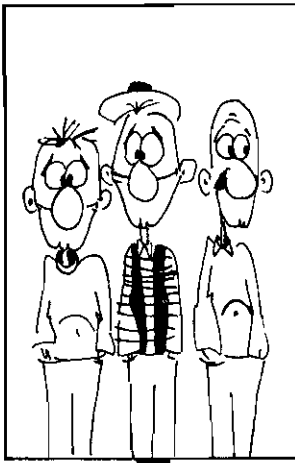

3

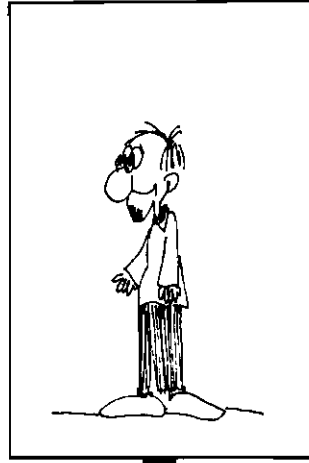

1



4



Complete

4 4 4 4 4 4 4



Cuenta

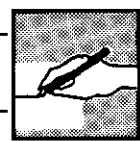

Escriba

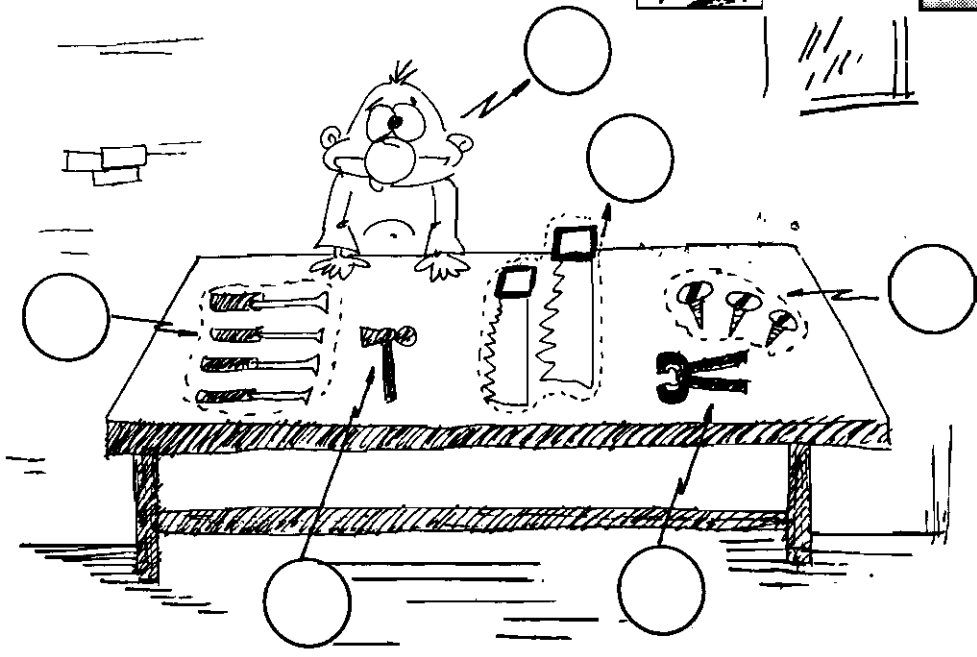



Escuche



Observe

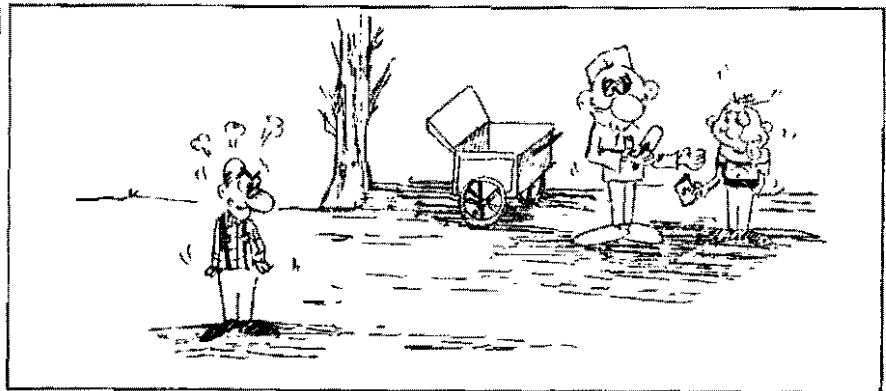
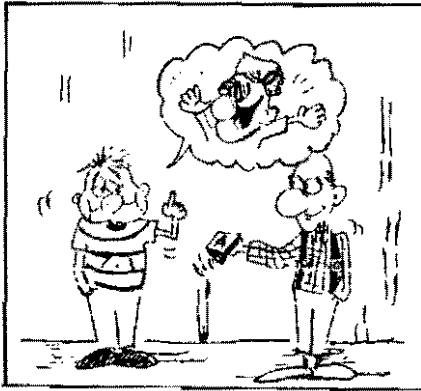
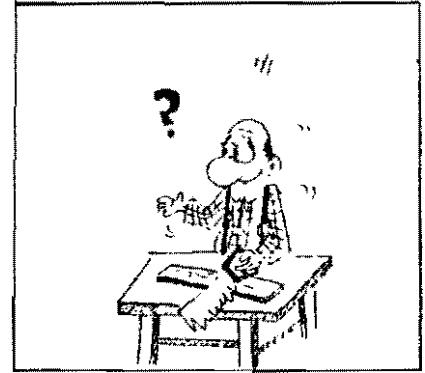
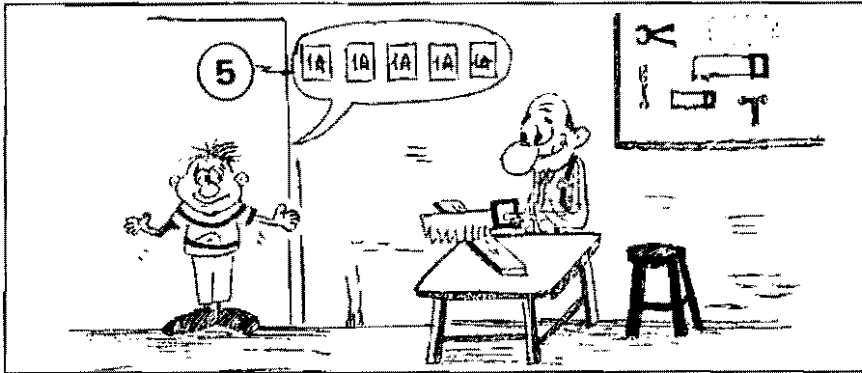

Observe

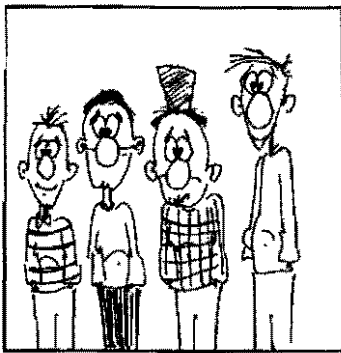

4



1

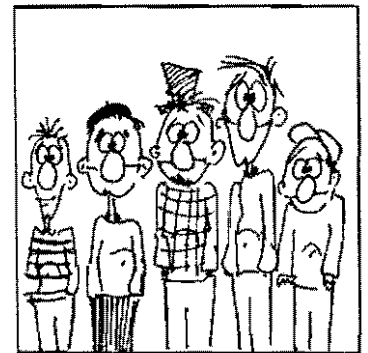

5



Complete

5 5 5 5 5 5 5





Cuente



Escriba

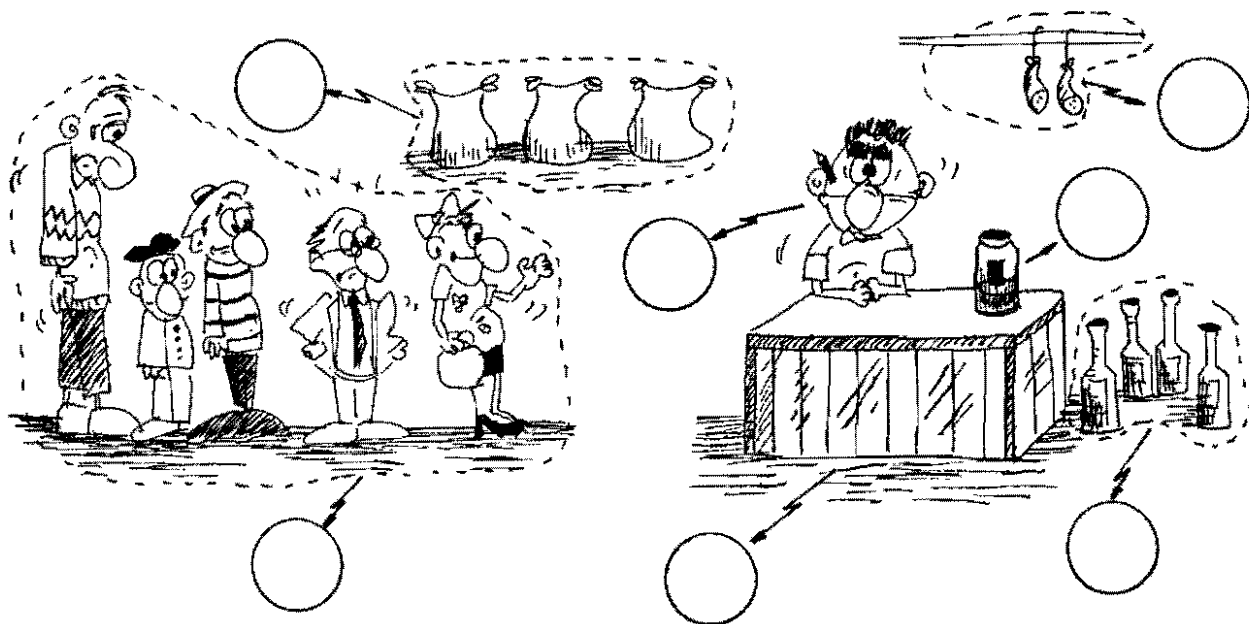

Observe



Cuente

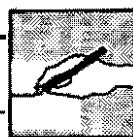

Escriba





Escriba

3

4

5



Escuche

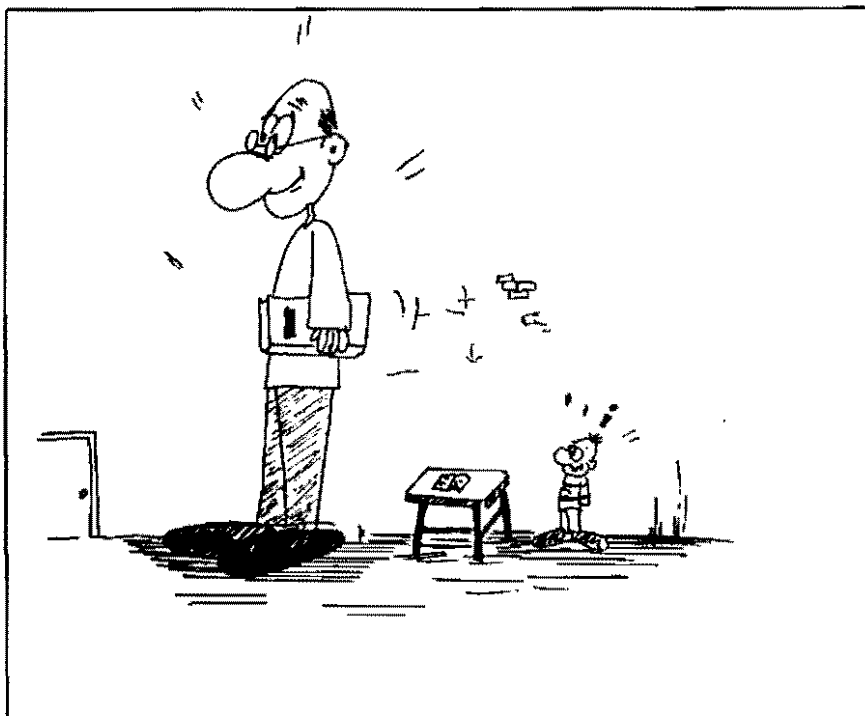
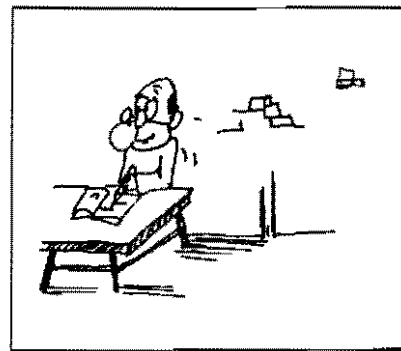



Observe



Lea

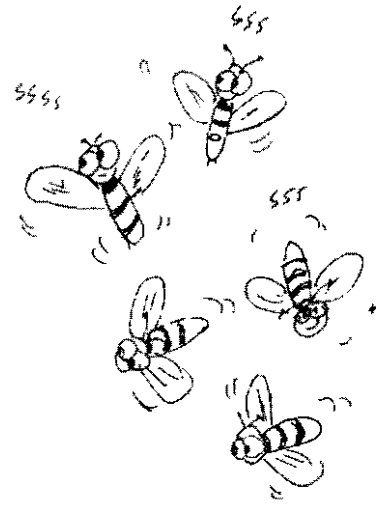
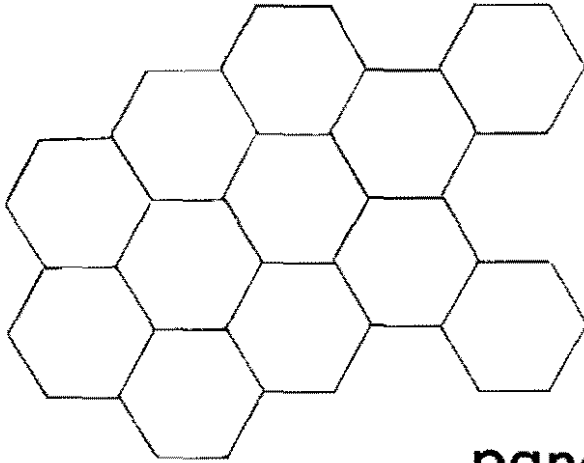

panal

pa	nal
----	-----

pa pe pi po pu

Pa Pe Pi Po Pu

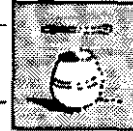

Complete



Lea

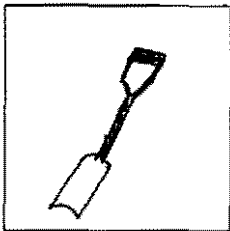

pala

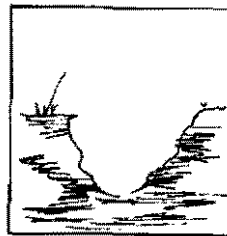

pozo



puma

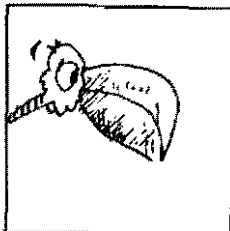

pico

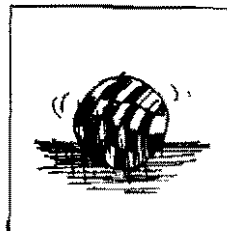

pelota



Paco



Lea



Escriba

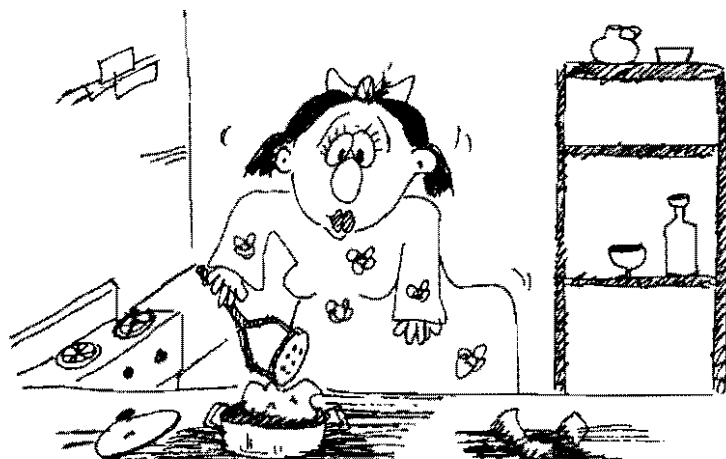
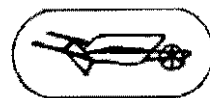

Pepa pisa pocas papas para puré.

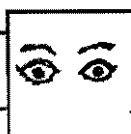

Observe



Escuche

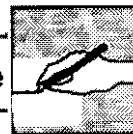

Escriba

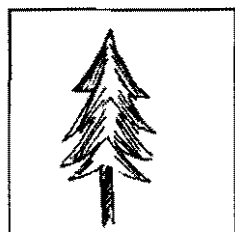

\_\_\_\_\_no



sa\_\_\_\_\_

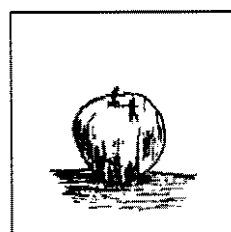

\_\_\_\_\_melo

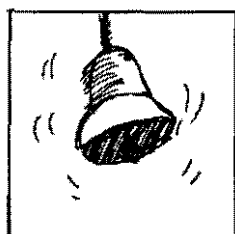

cam\_\_\_\_\_na

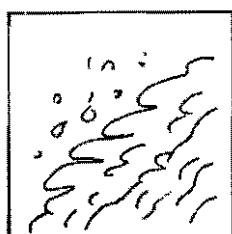

es\_\_\_\_\_ma

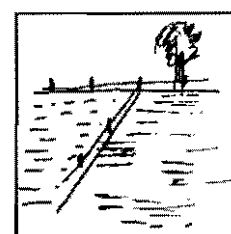

cam\_\_\_\_\_



Lea

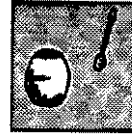



Relacione



Escriba

pa pa papa 

pa Pe pa Pepa 

Pe pe Pe 

pi pi 

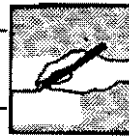

Escriba



Cuenta

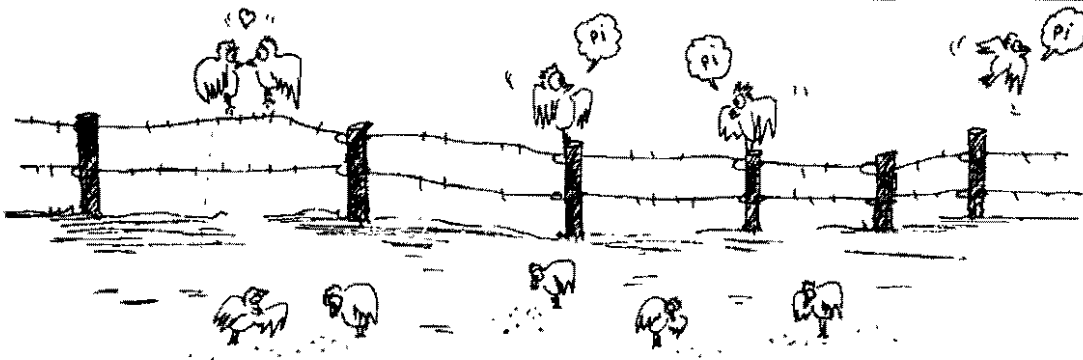

¿Cuántos pájaros pían?



¿Cuántos pájaros comen en el pasto?





Escuche



Observe

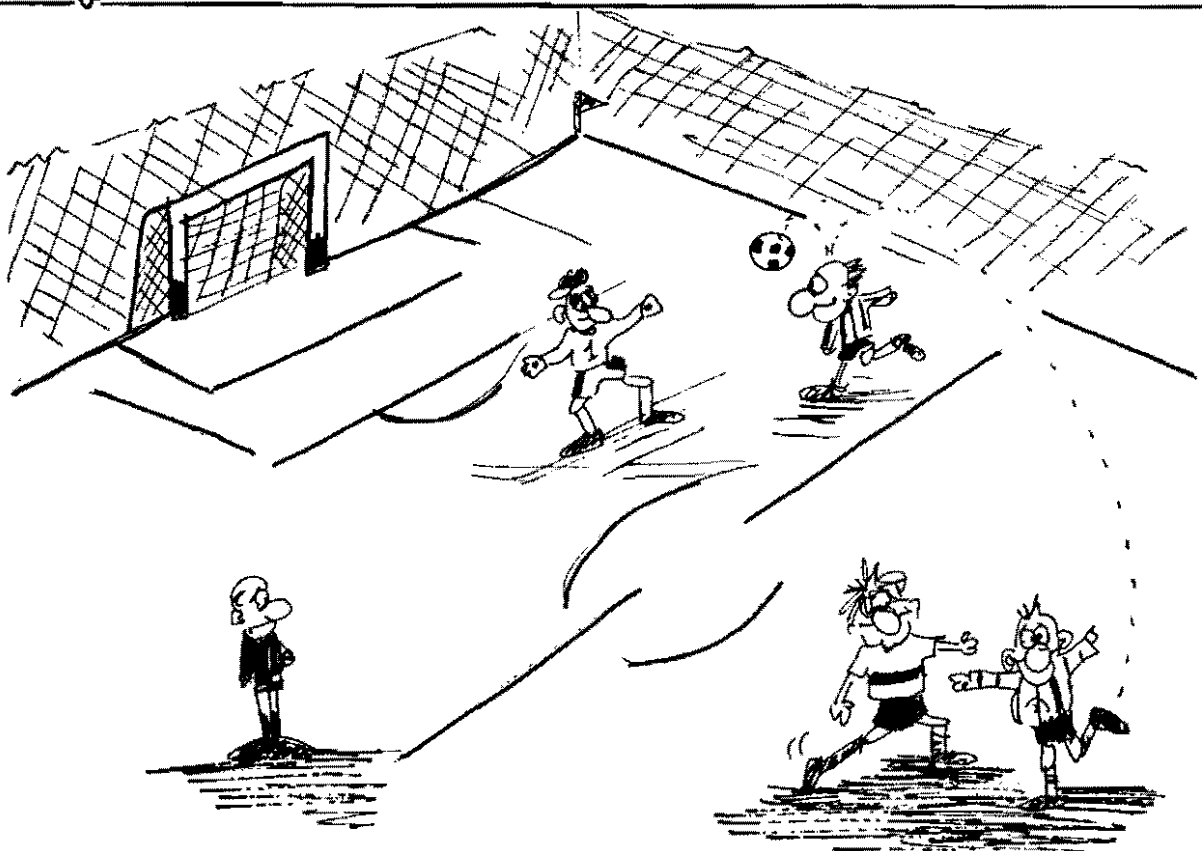
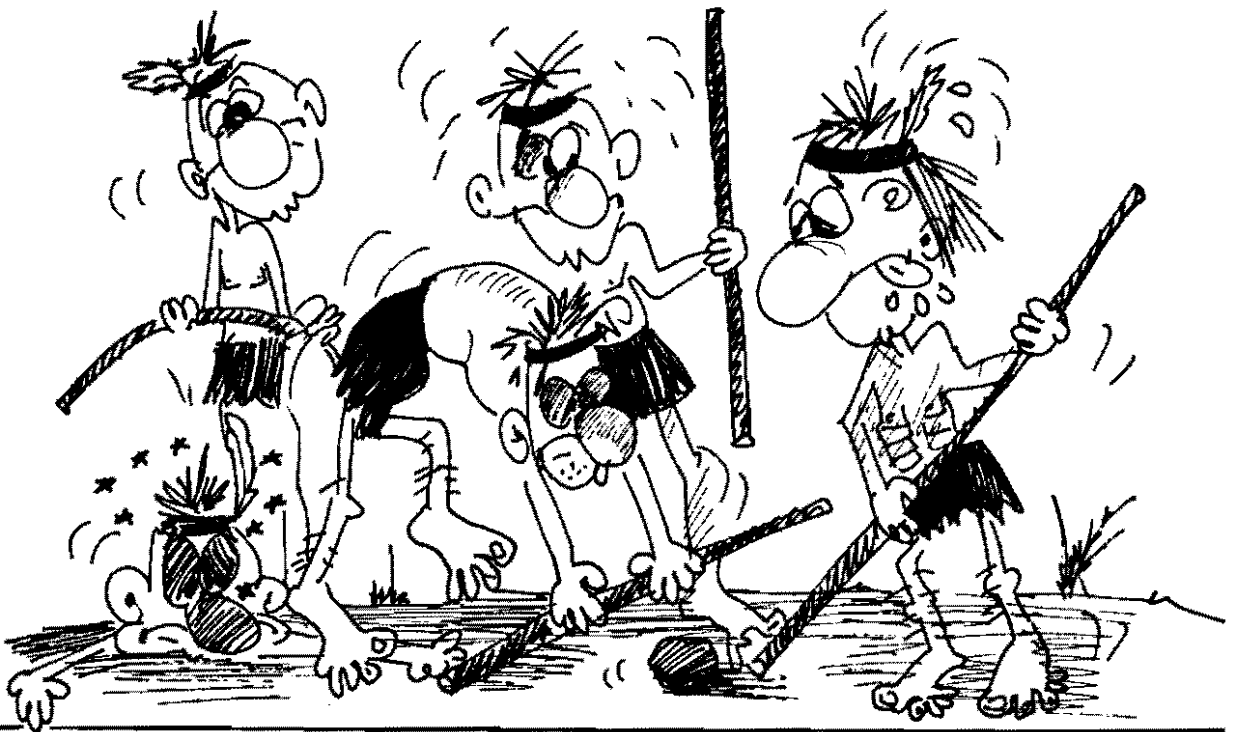



Compruebe

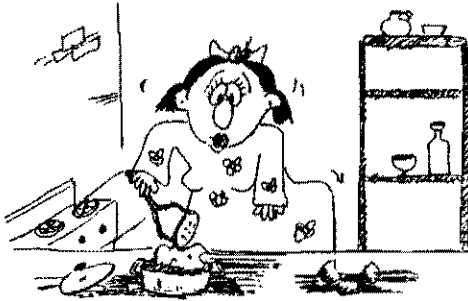

pino



sapo



pomelo

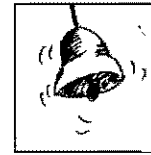

campana

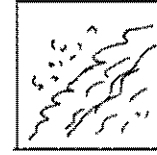

espuma



campo

Pepa pisa pocas papas para pure

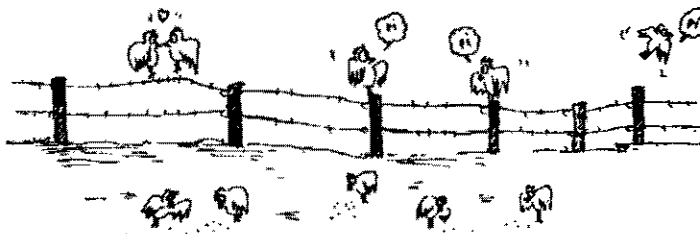
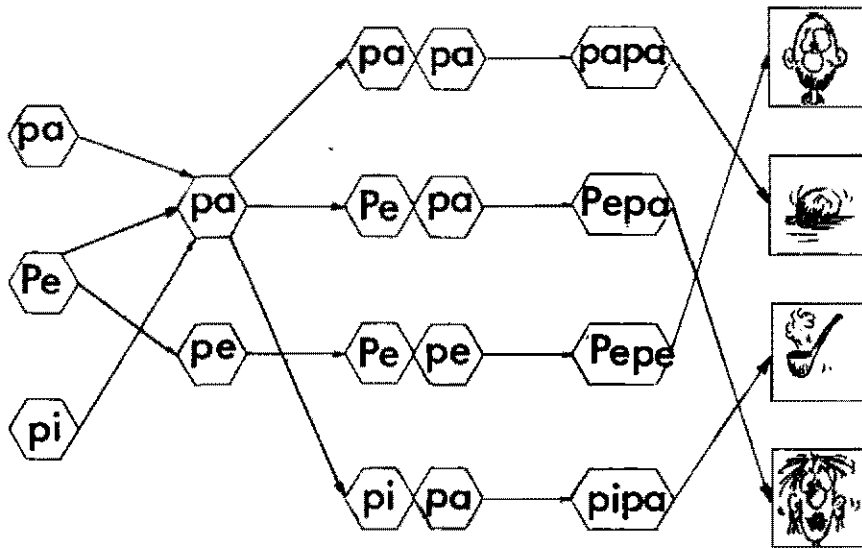

¿Cuántos pájaros pían?

3

¿Cuántos pájaros comen en el pasto?

5



Escuche



Lea



sopa

so	pa
----	----

so se si sa su

So Se Si Sa Su

os es is as us





Escuche



Comple

sopa

salero

semilla

silla

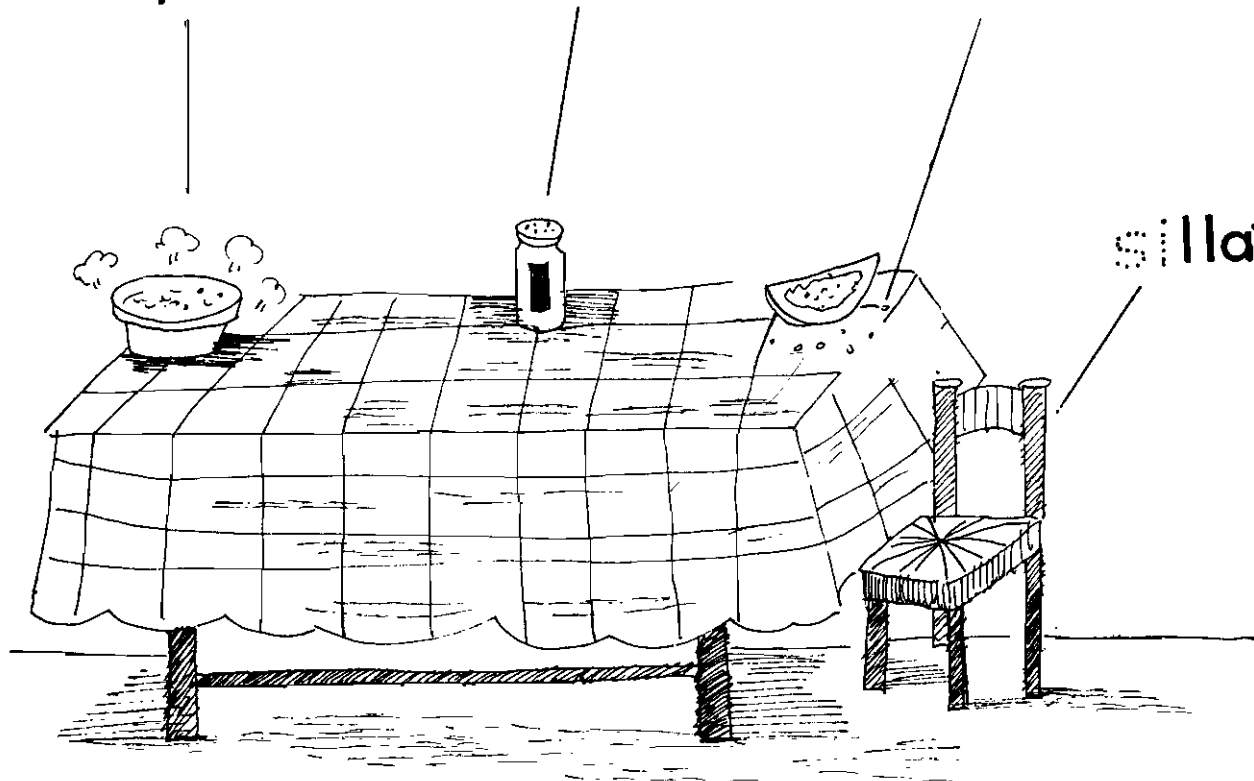

Escuche

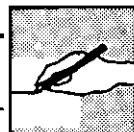

Escriba

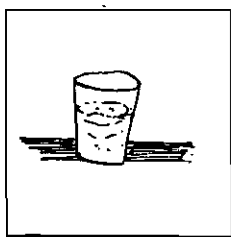

va .....

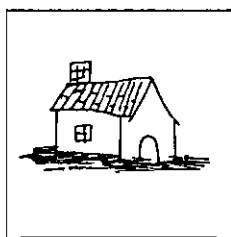

ca .....

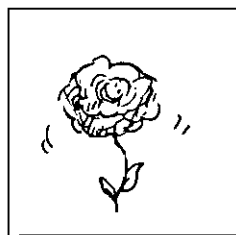

ro .....

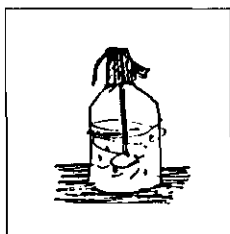

...da

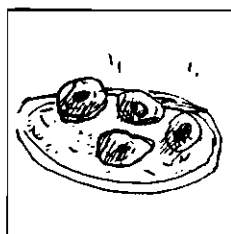

ma ... tas



...ra



Lea

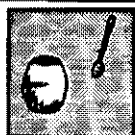

Relacione



Sosa pisa papas

Susi puso ese apio así

Pepa supo su peso



Lea



Relacione

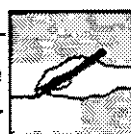

Escriba

pa → sa → pasa

pi → so →

pe → sa →

so → pa →



Escuche



Escriba



Susi se salió con la suya.



Escuche



Escriba

- as
- es
- is
- Os
- us

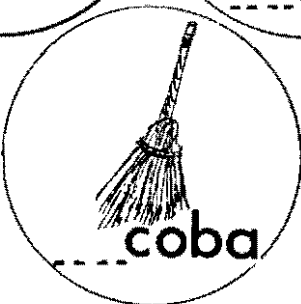
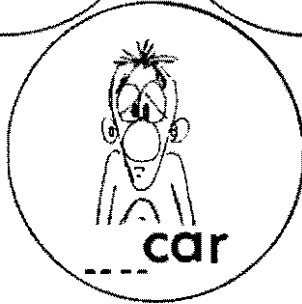
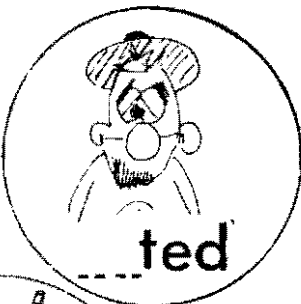
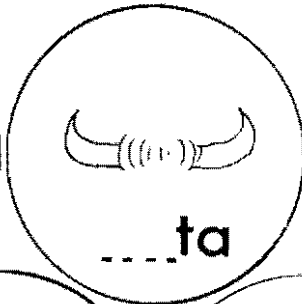
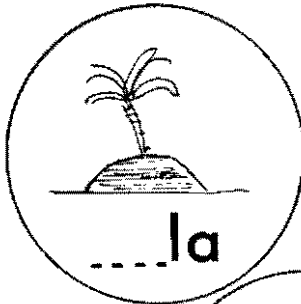



Compruebe

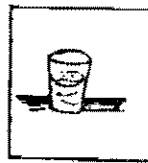

vaso



casa



rosa



soda



masitas



Sara

pa → sa → **pasa**

pi → so → **pi so**

pe → sa → **pesa**

so → pa → **sopa**

Sosa pisa papas

Susi puso ese apio así

Pepa supo su peso

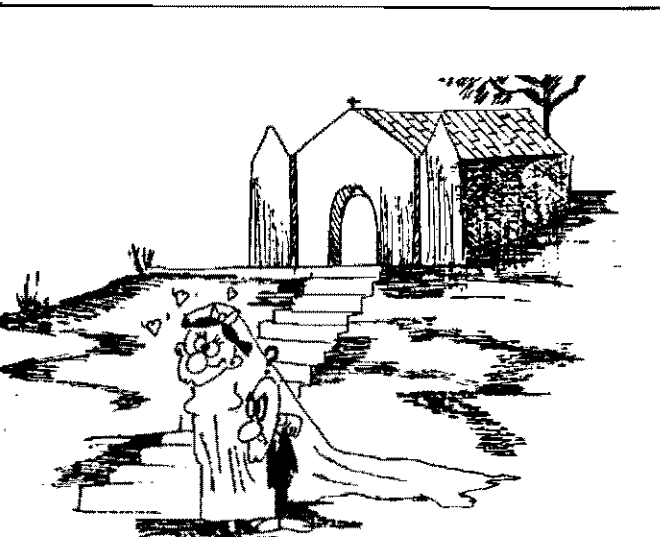
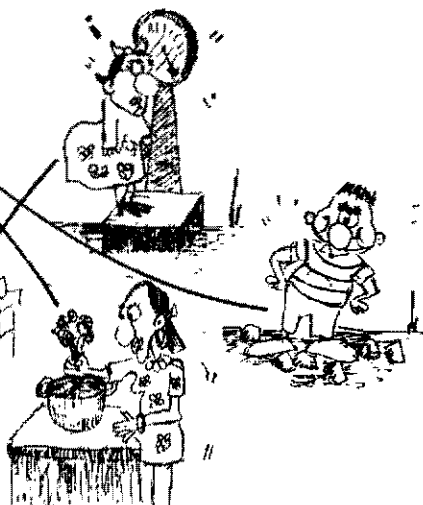

Susi se salió con la suya.

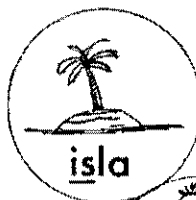

isla



asta



usted



Oscar

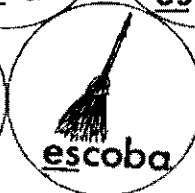

escoba

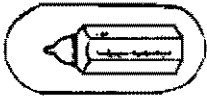

Escuche



Observe

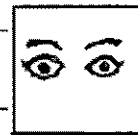
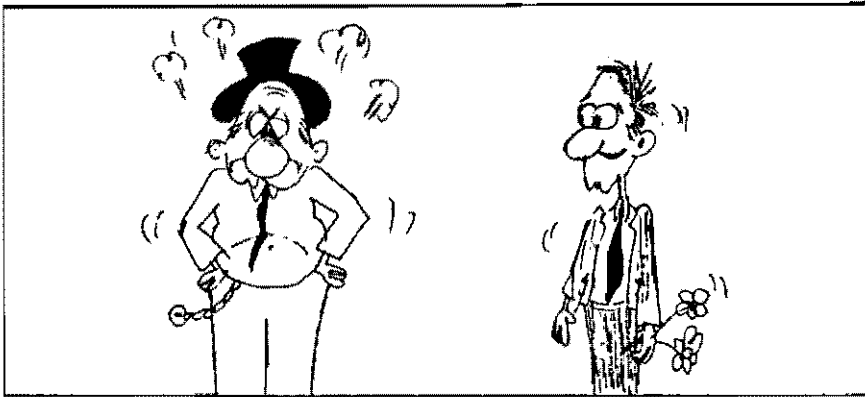
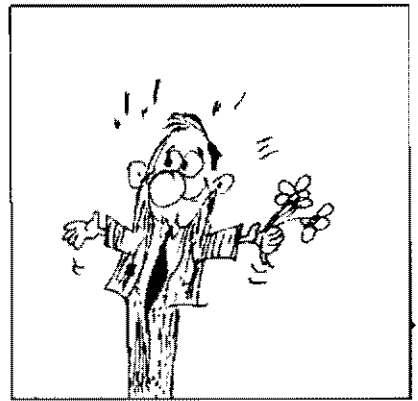
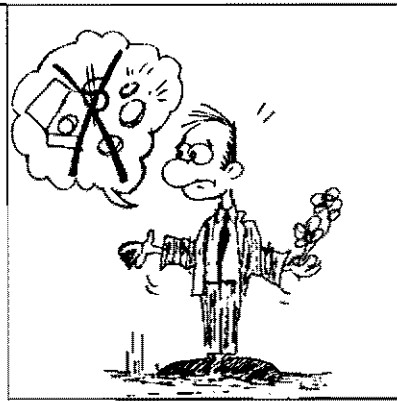
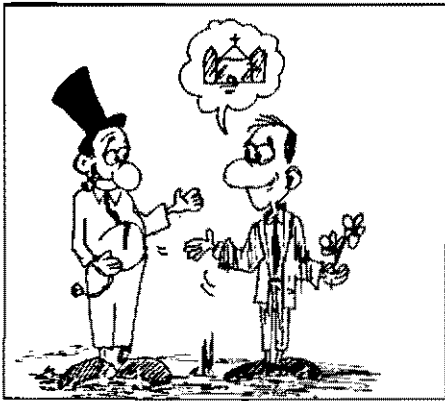

Observe

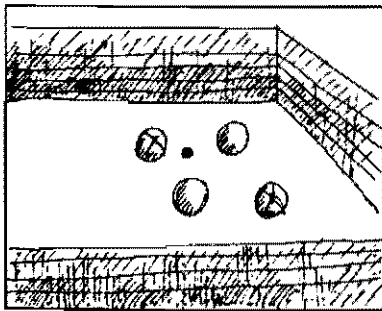

5



1

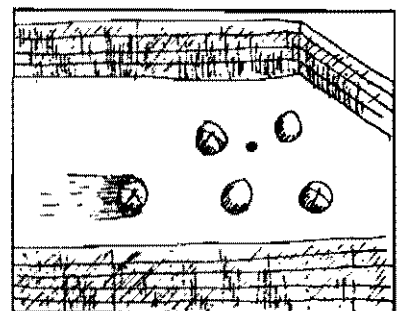

6



Complete

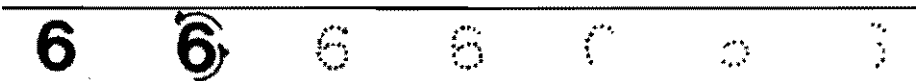



Escuche



Observe

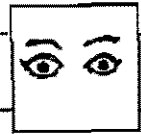
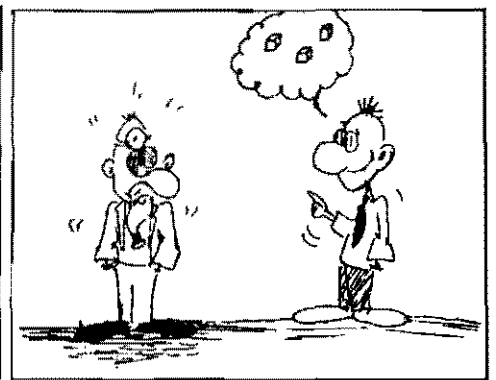
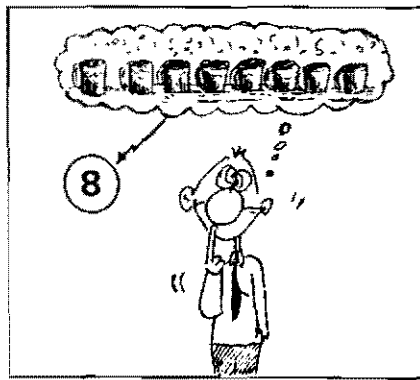
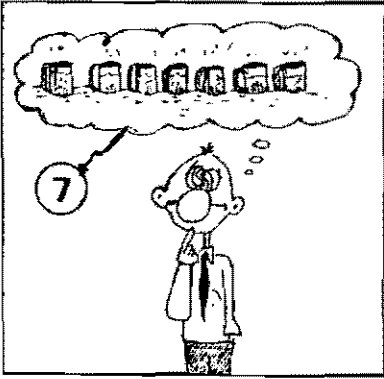
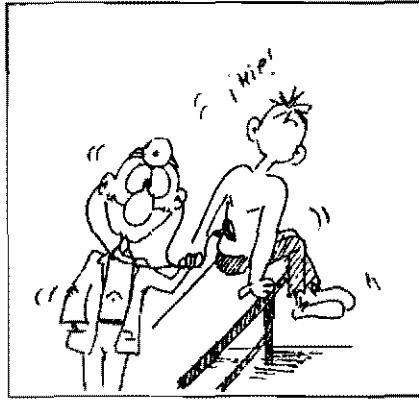
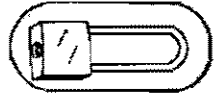

Observe

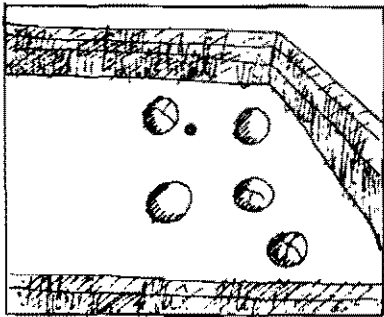

6



1

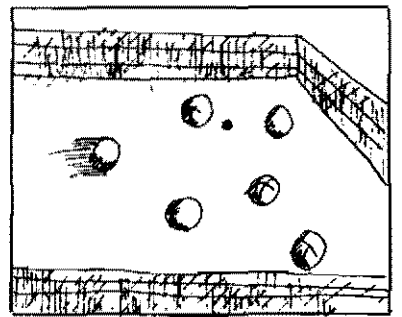

7



Complete

7 7/ 7 7 / /



Observe

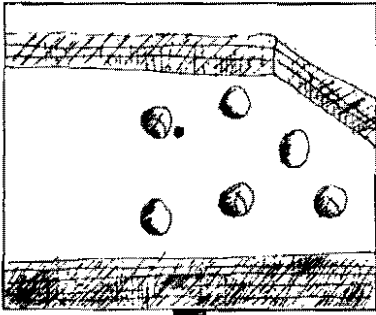

7

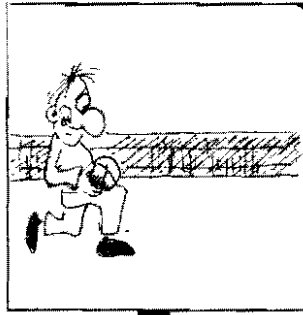

1

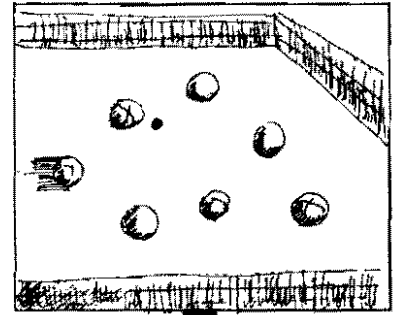

8



Complete

8 8 8 8 8 8



Cuenta



Escriba

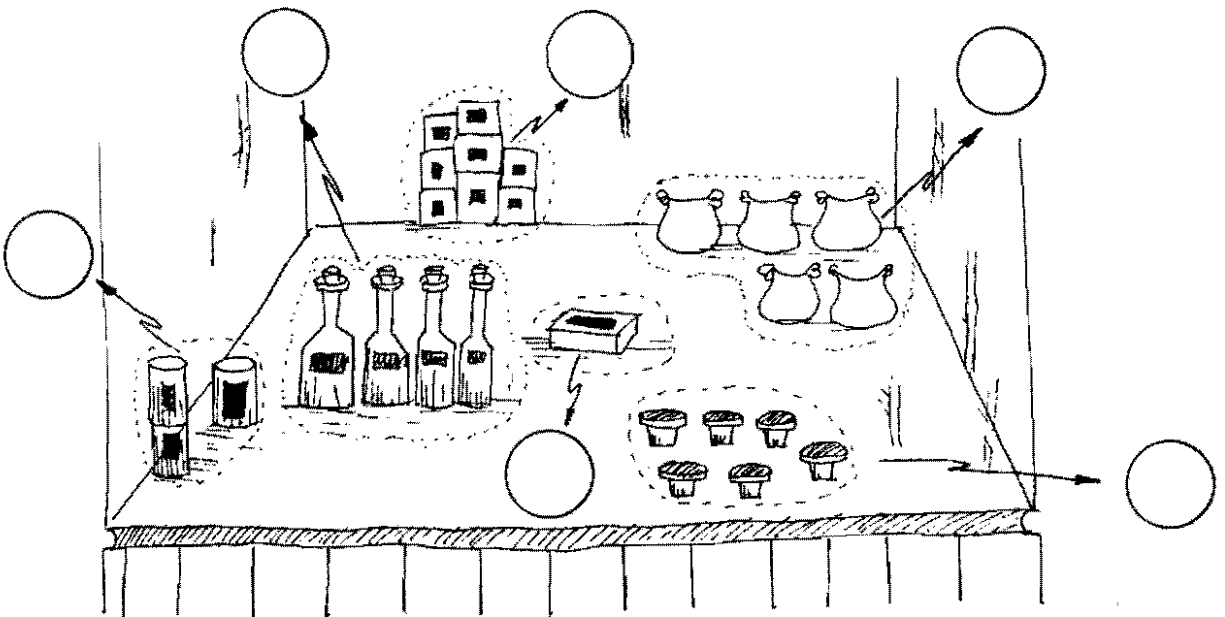

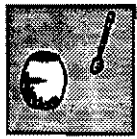

Relacione



Escriba

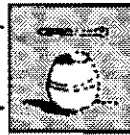
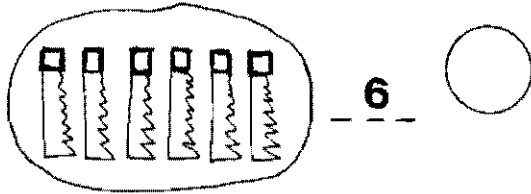
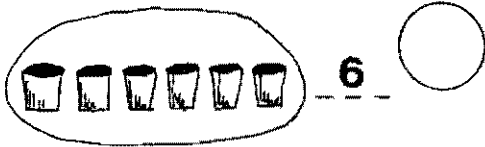
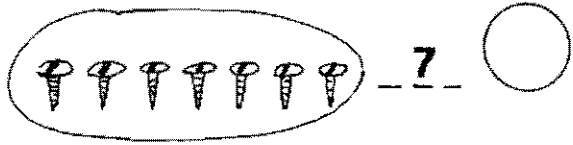
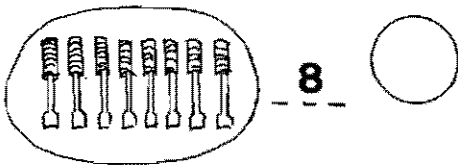
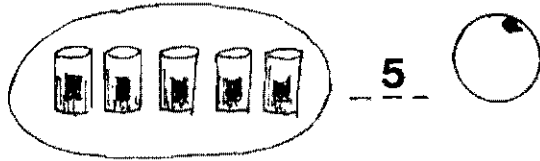
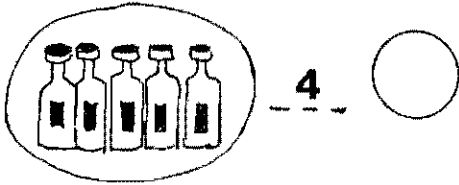
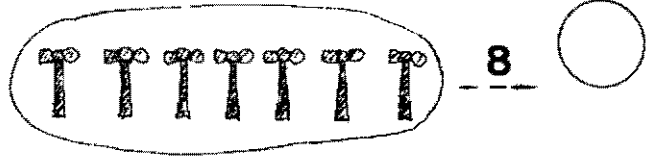
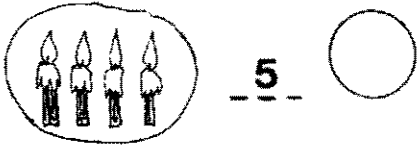

Complete



Escriba

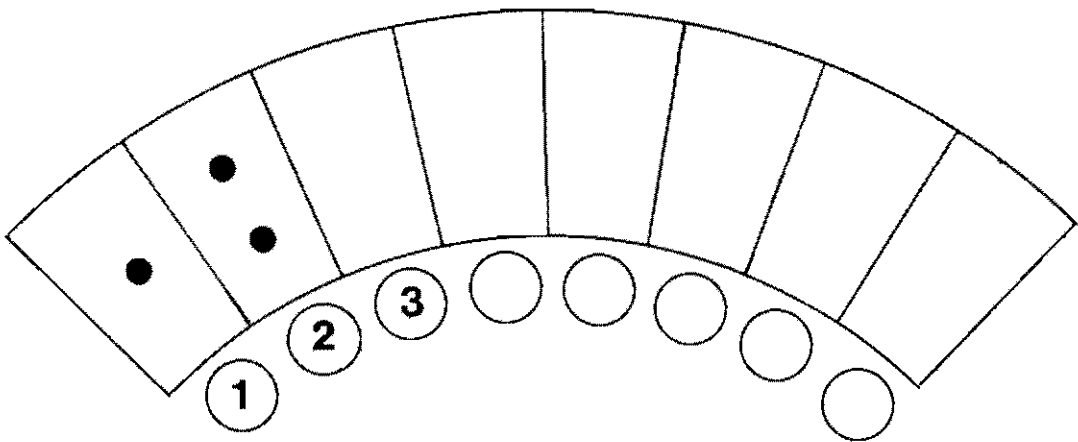





Escriba

6

7

8



Escuche

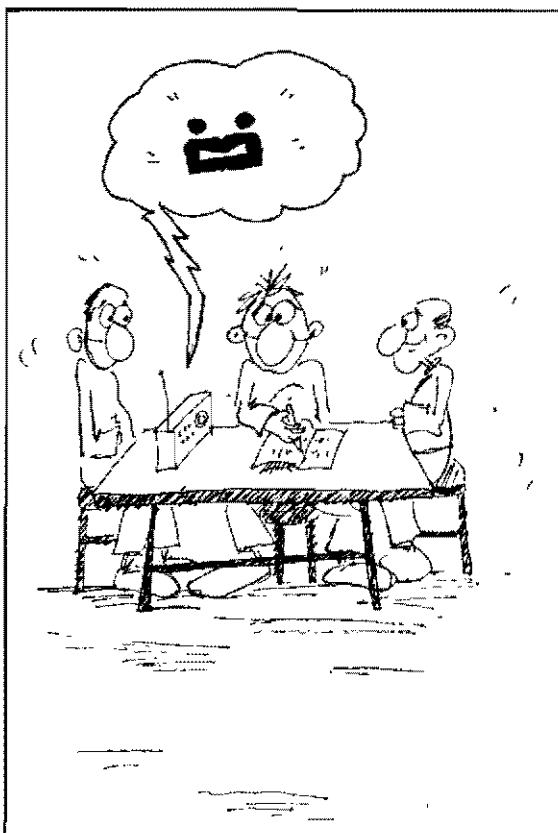
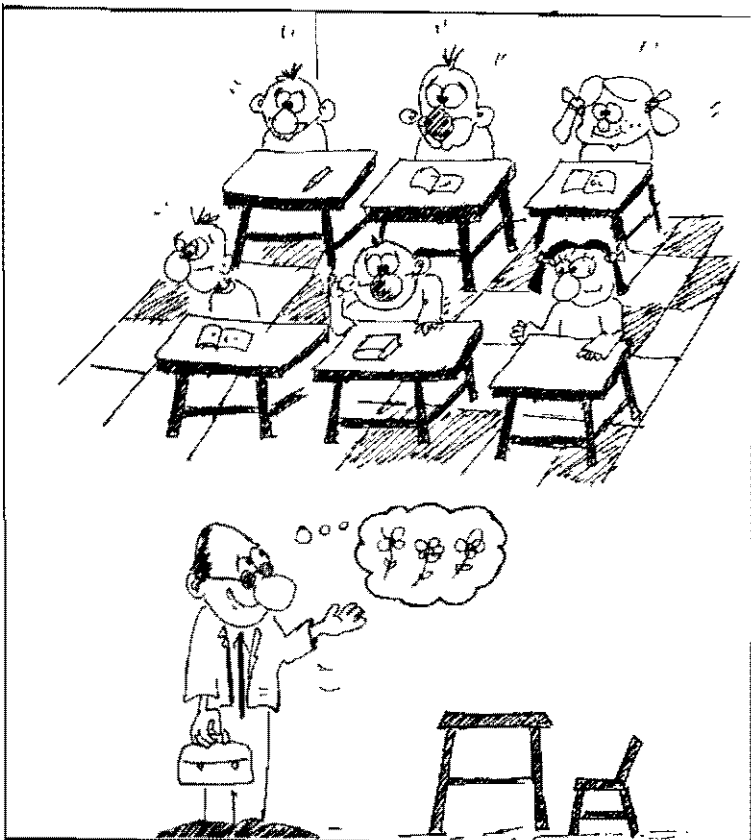
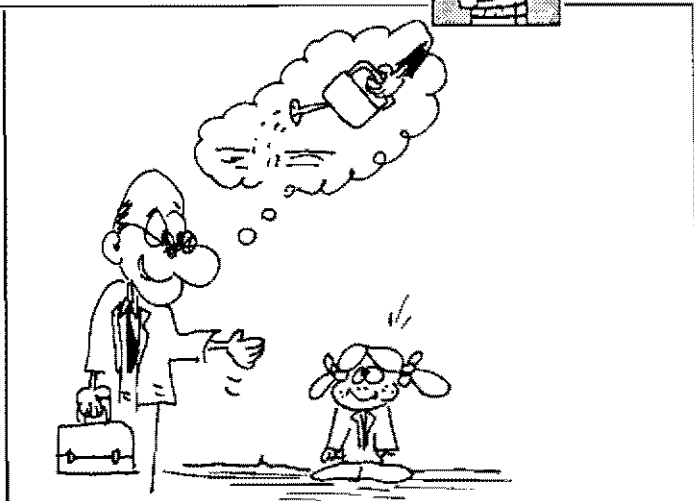
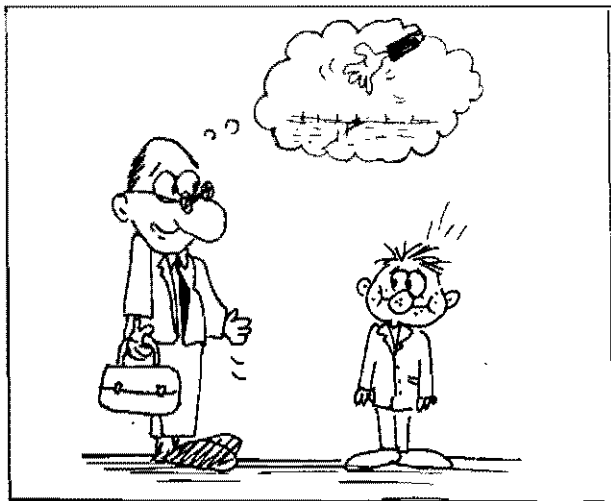





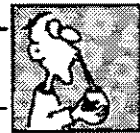
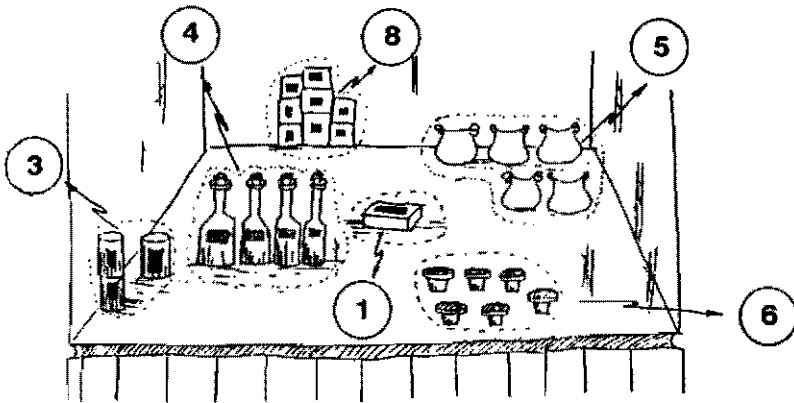













Comprueba



Comprueba

 - 5 -		 - 8 -	
 - 4 -		 - 5 -	
 - 8 -		 - 7 -	
 - 6 -		 - 6 -	

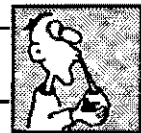

Comprueba

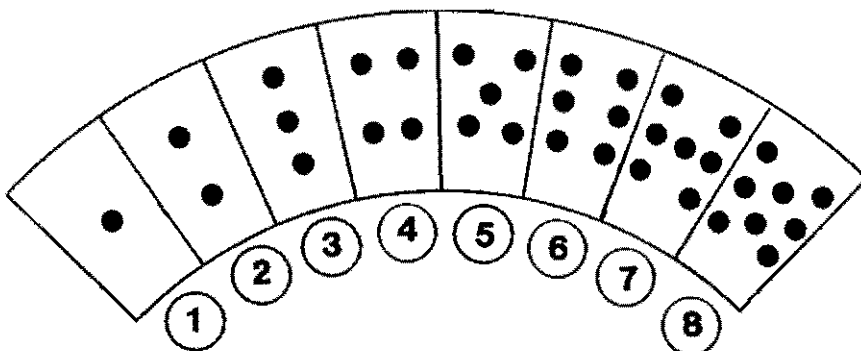

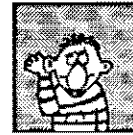

Escuche



Observe

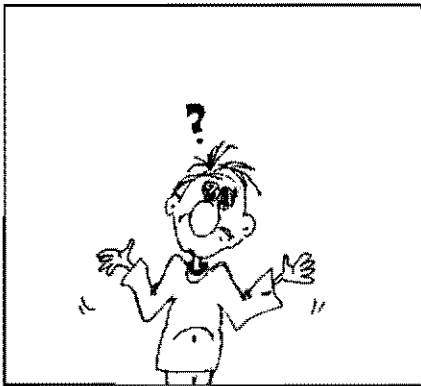
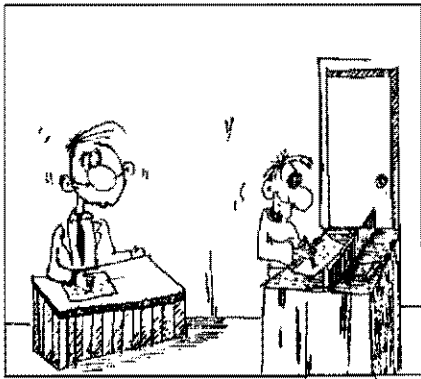

Observe



8

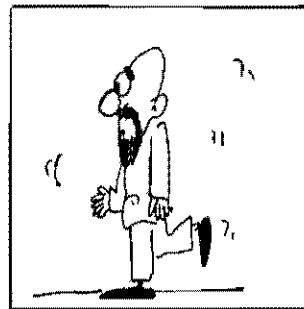

1



9



Complete

9 9 9 9 9 9



Cuenta



Relacione

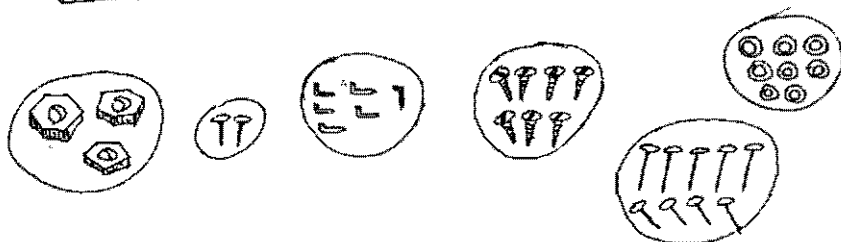
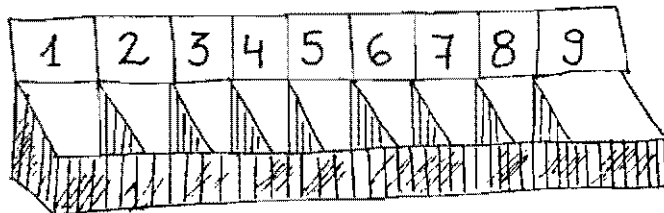
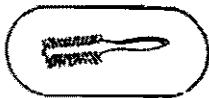

Escuche

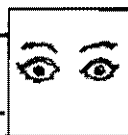

Observe

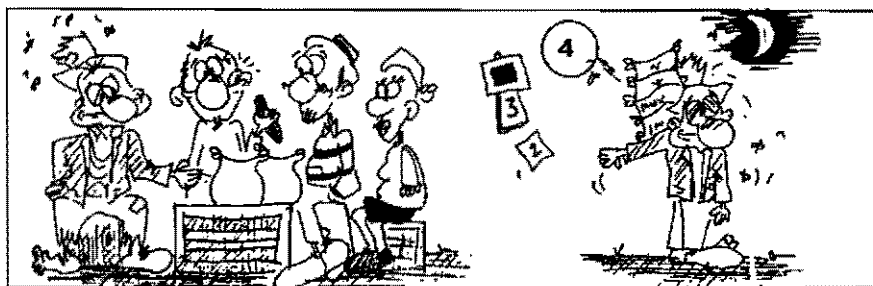



Cuenta



Escriba

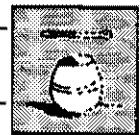
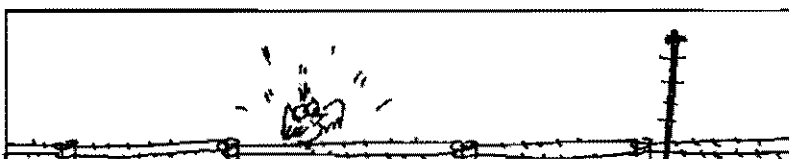

Complete



Complete

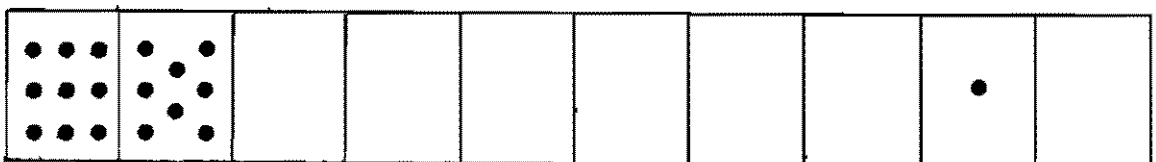



Escriba



8

9

0



Escuche



Observe

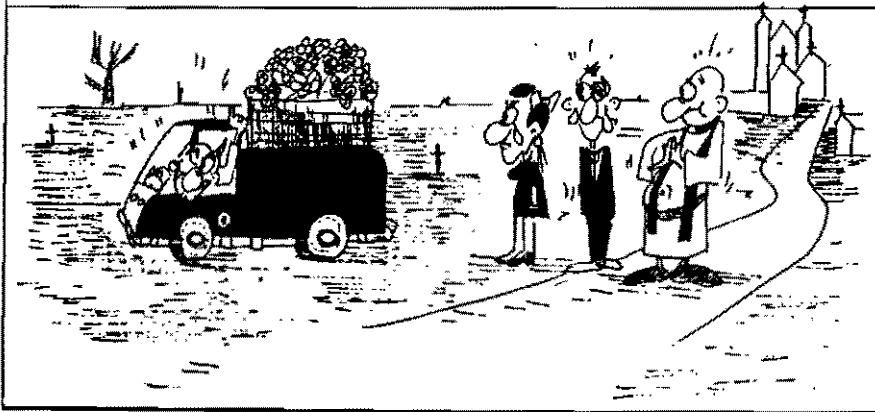
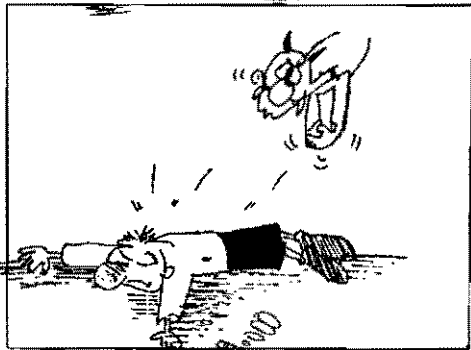
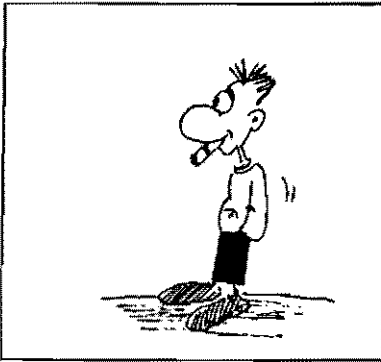

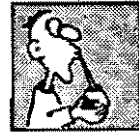

Compruebe

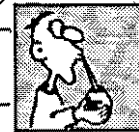
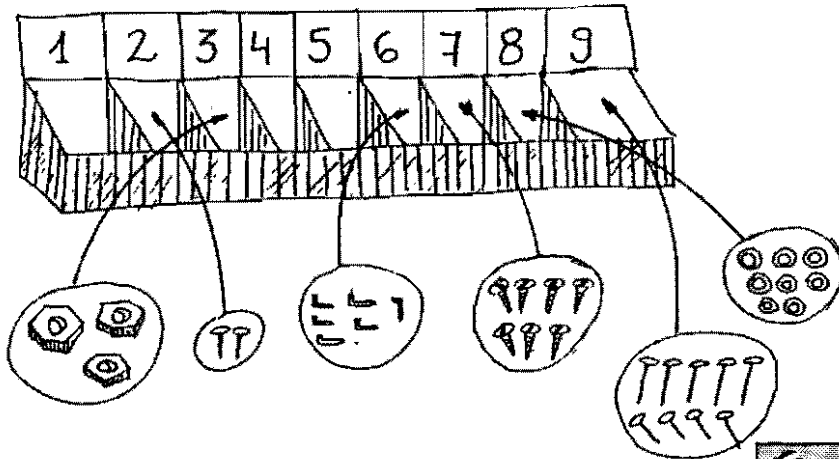

Compruebe

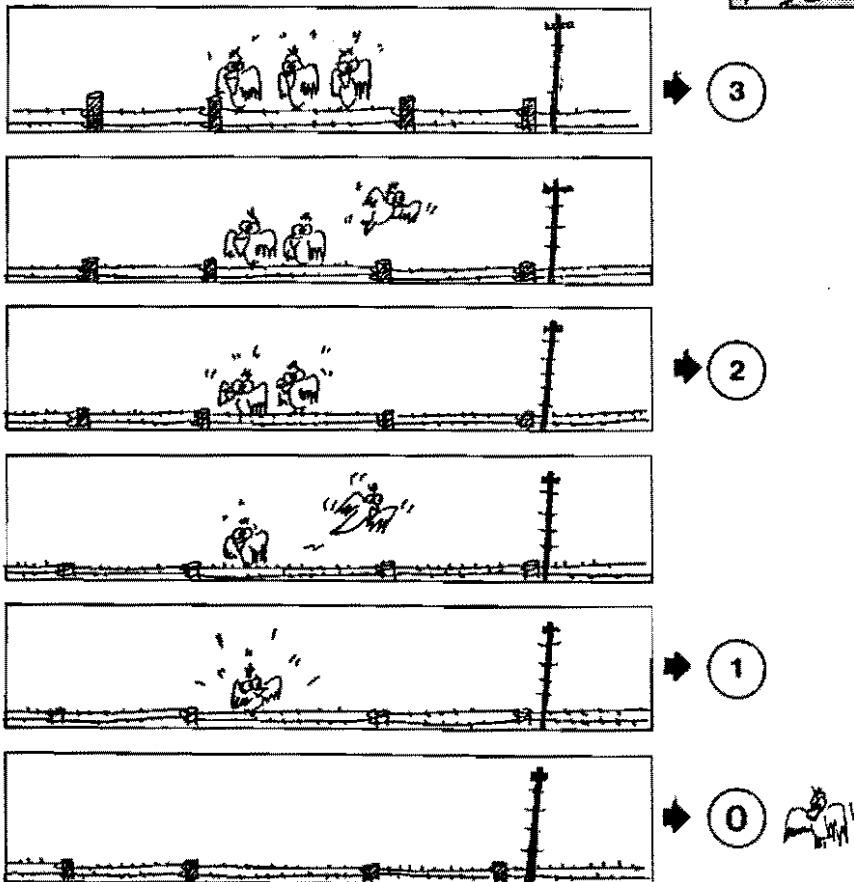

Compruebe

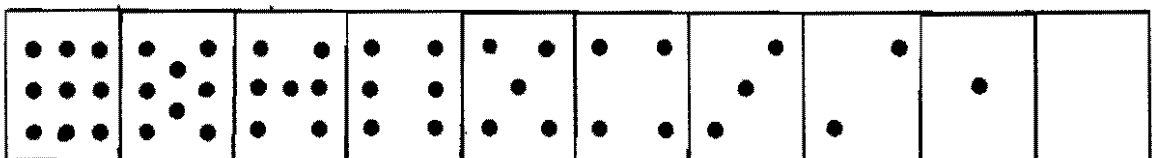



Esuche



Observe

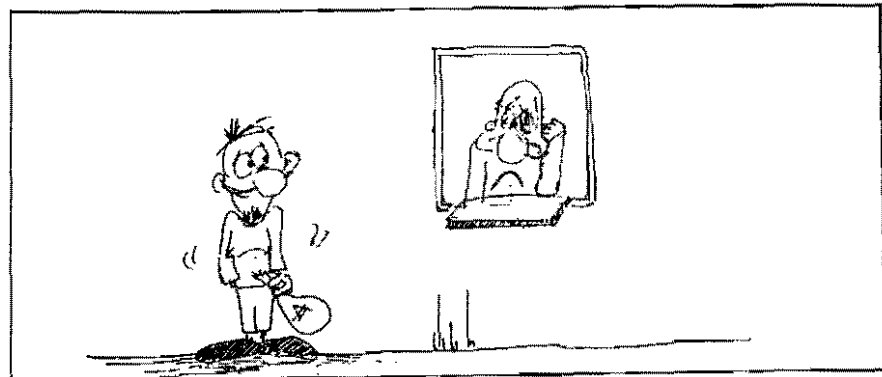
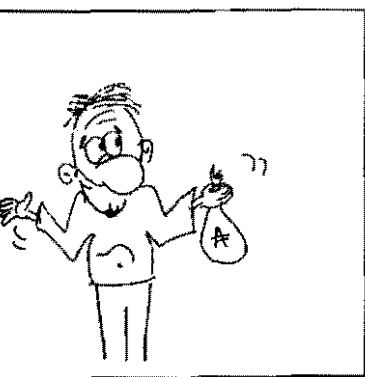
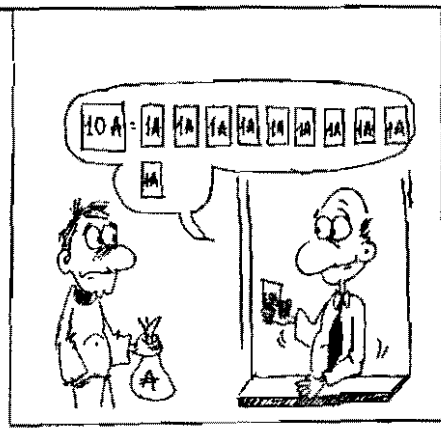
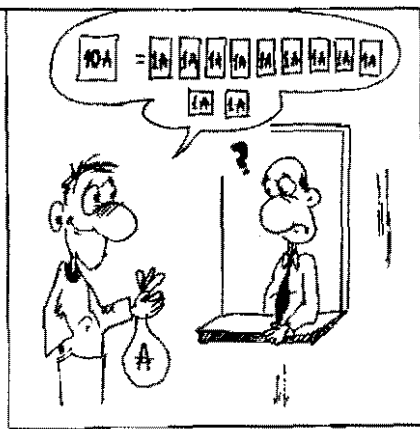
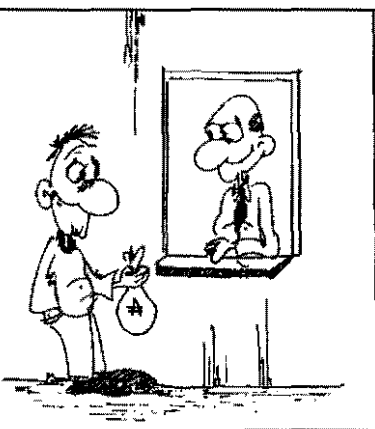

Esuche



Observe

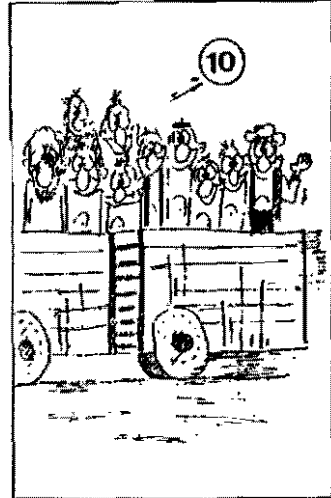
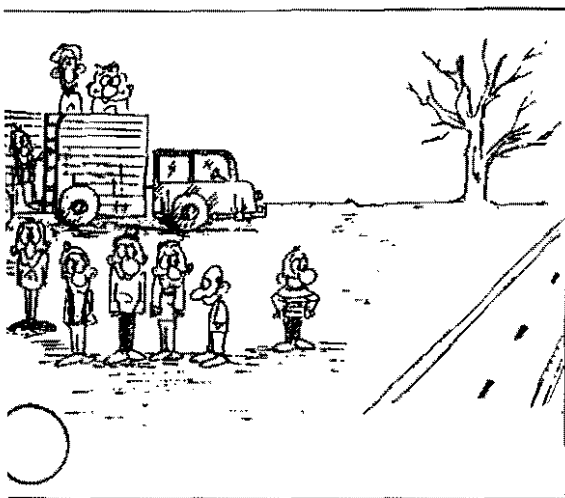



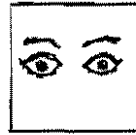

Observe



Escriba



10 unidades forman 1 decena

$$10u = 1d$$



Completa

10	10	10									
----	----	----	--	--	--	--	--	--	--	--	--



Observe

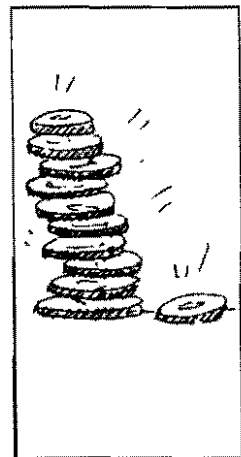
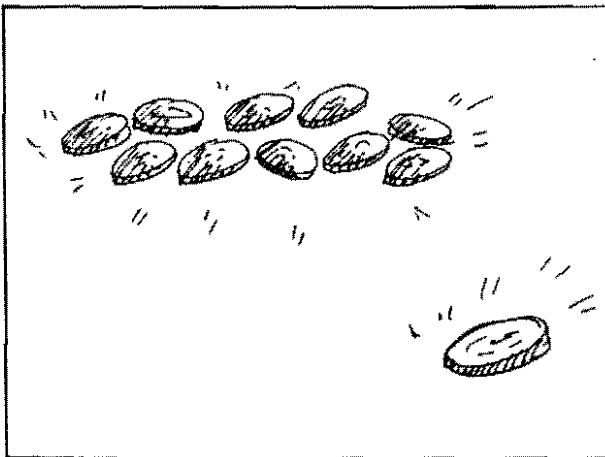

1d 1u

d	u
1	1



Completa

11	11	11								
----	----	----	--	--	--	--	--	--	--	--



Escuche



Observe

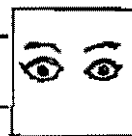
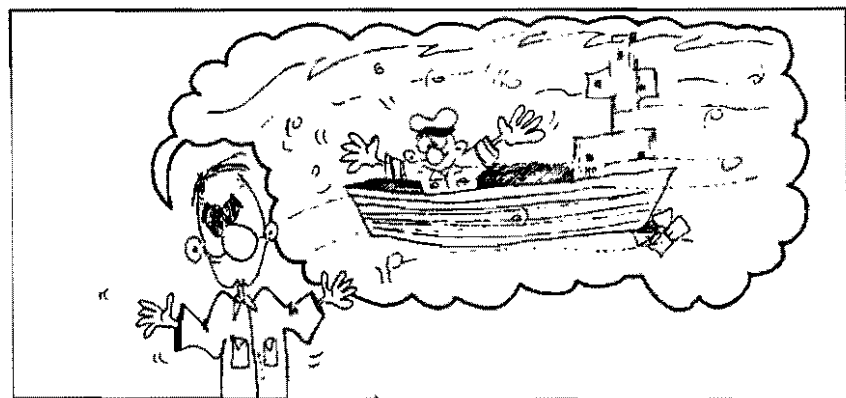
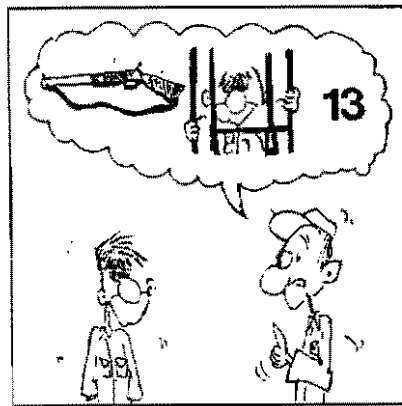

Observe

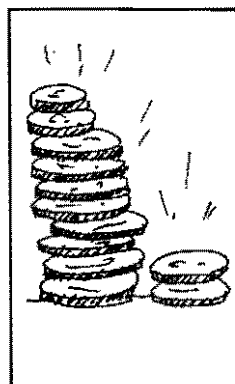
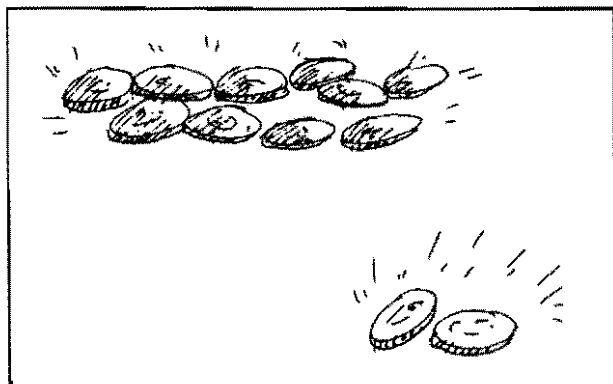

d	u
1	2

1d 2u



Complete

12 12 12



Observe

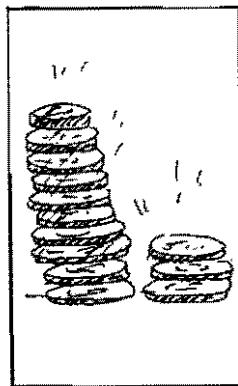
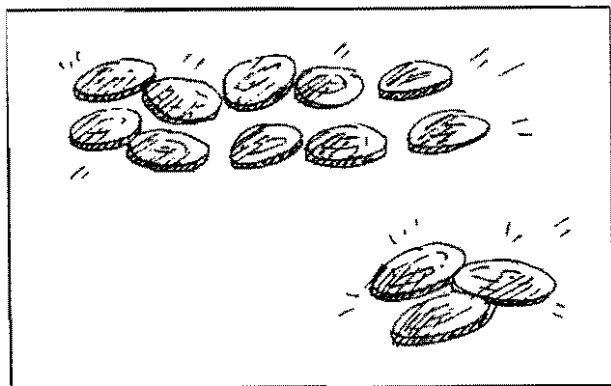

d	u
1	3

1d 3u



Complete

13 13 13

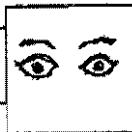

Observe

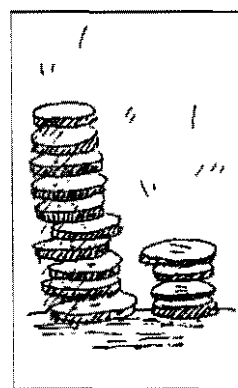
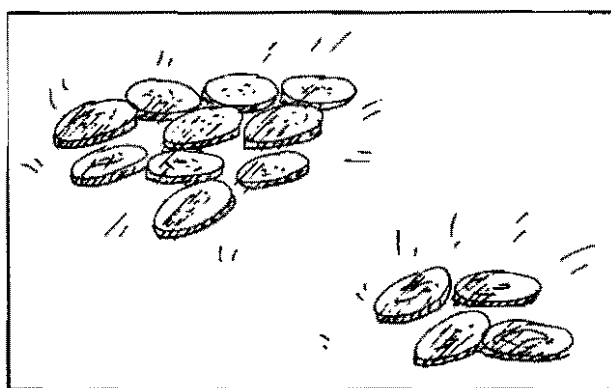

d	u
1	4

1d 4u

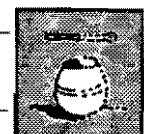

Complete

14 14 14



Cuenta



Escriba

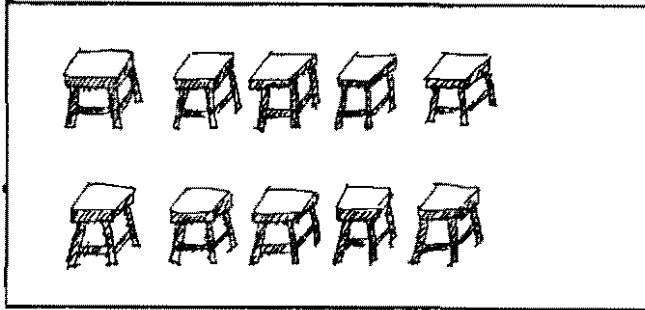

d	u

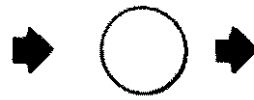
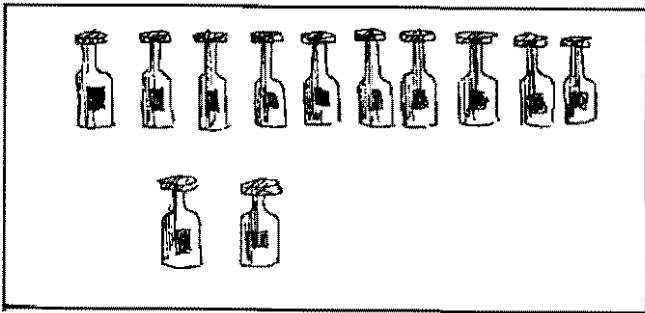

d	u

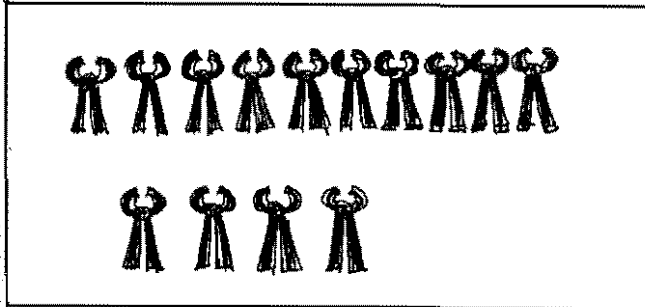

d	u

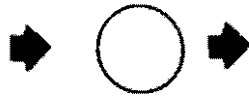
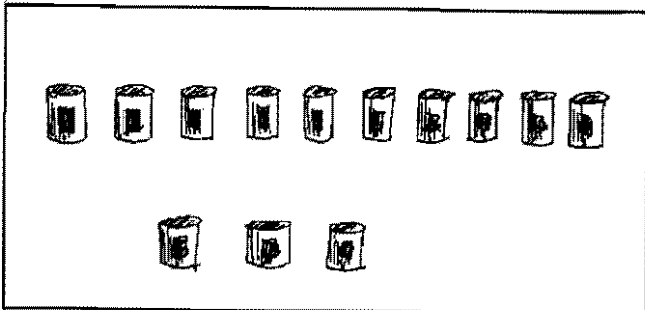

d	u

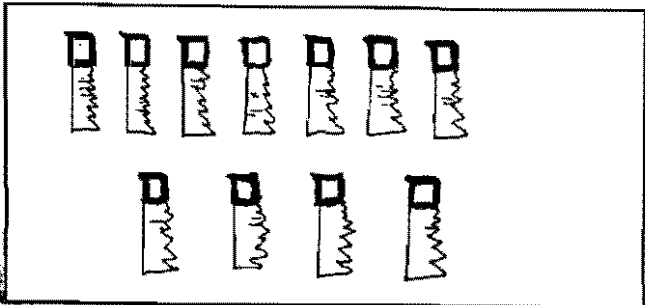

d	u



Escrib

10

11

12

13

14

\_\_\_\_\_

\_\_\_\_\_



Escuche



Observe

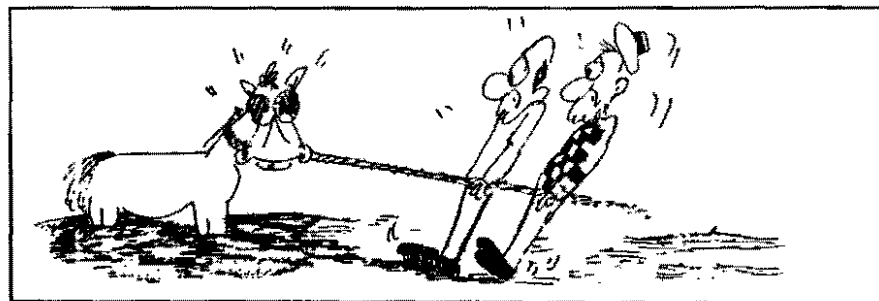
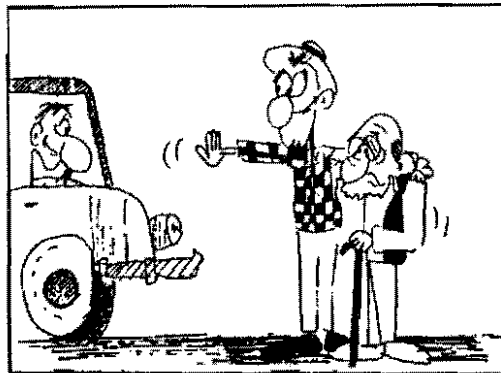
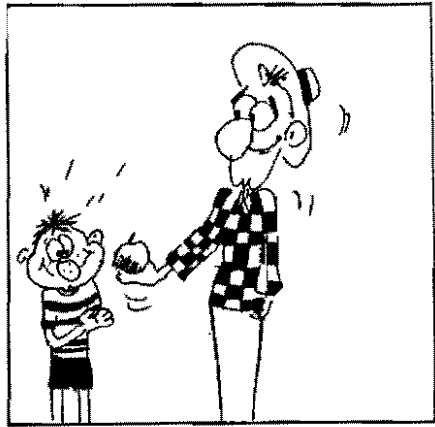
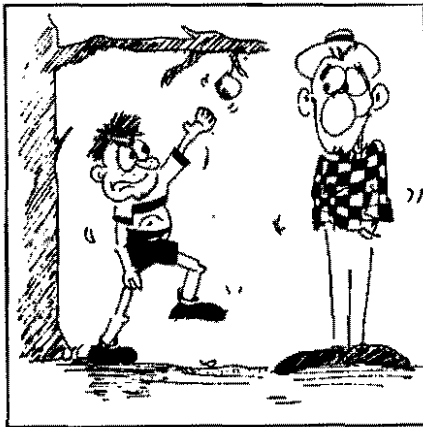



Compruebe

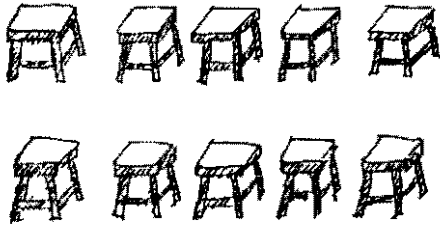

→ (10) →

d	u
1	0

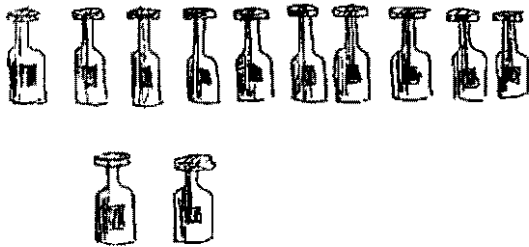

→ (12) →

d	u
1	2

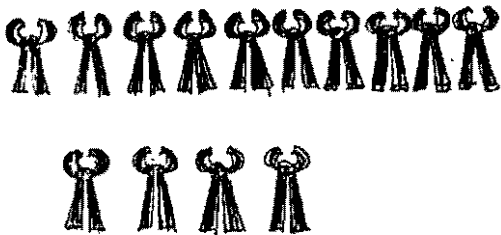

→ (14) →

d	u
1	4

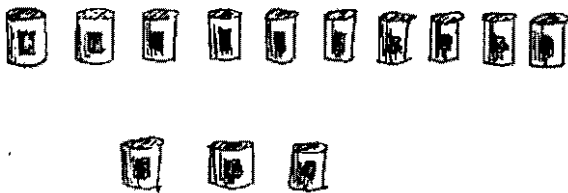

→ (13) →

d	u
1	3

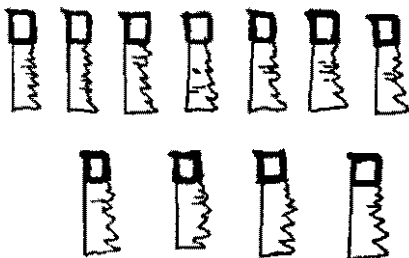

→ (11) →

d	u
1	1

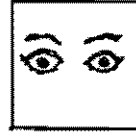

Observe



Le



luna

lu	na
----	----

lu le la li lo

Lū Le La Li Lo

ul el al il ol



Lea



Lía usa la lupa.

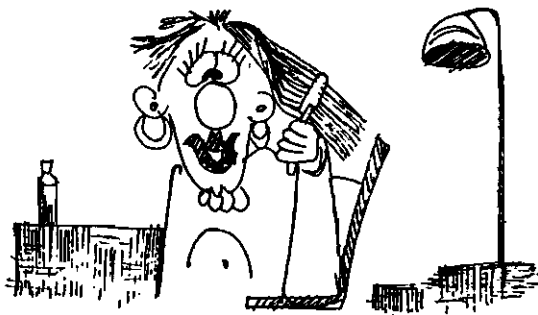

Paula alisa su pelo,

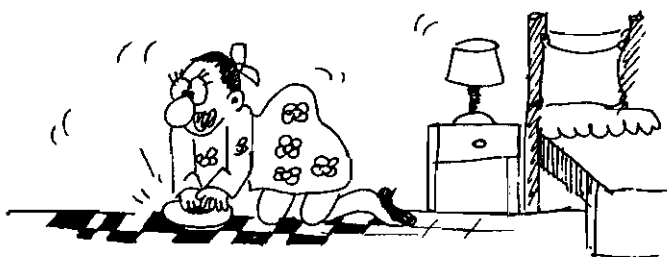

Lola pule los pisos.



Lea

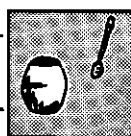

Relacione

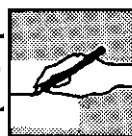

Escriba

1 \_\_\_\_\_

2 \_\_\_\_\_

3 \_\_\_\_\_

4 \_\_\_\_\_

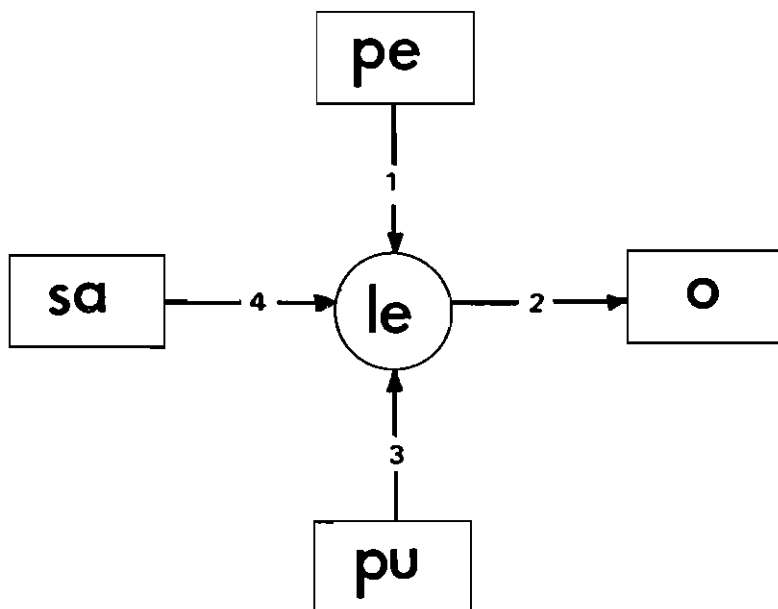





Lea



Relacione



Escriba

Lila

olió

pala



pasea sola.

Su esposo usa la



Elisa



ese alelí.

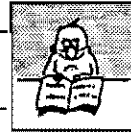

Lea



Relacione

al

el

il

ol

ul

Elsa pasea.

Saul usa pilas.

Lía sale al sol.

Pipo puso el pie.



Esouche



Observe

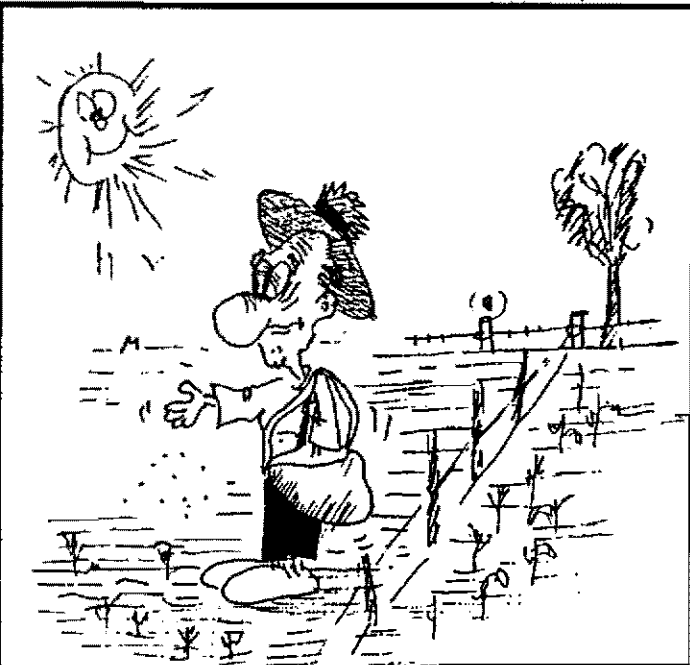

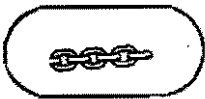

- 1 pele
- 2 leo
- 3 pule
- 4 sale

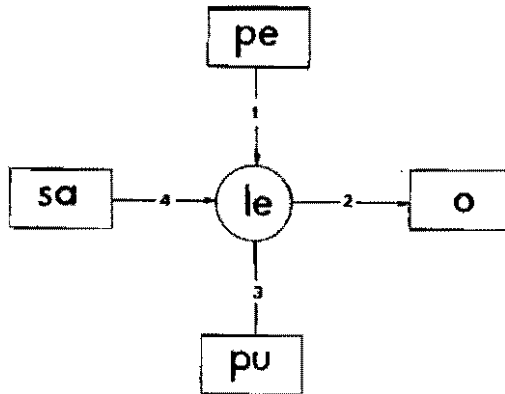

Lila pasea sola.

Su esposa usa la pala

Elisa olió ese alelí.

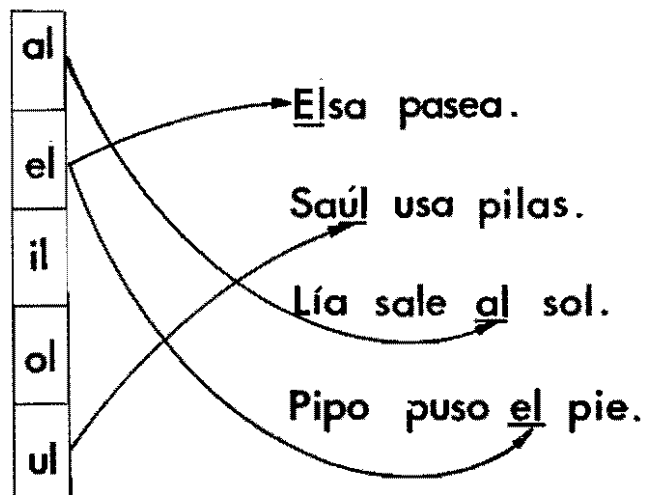



Escuche



Observe

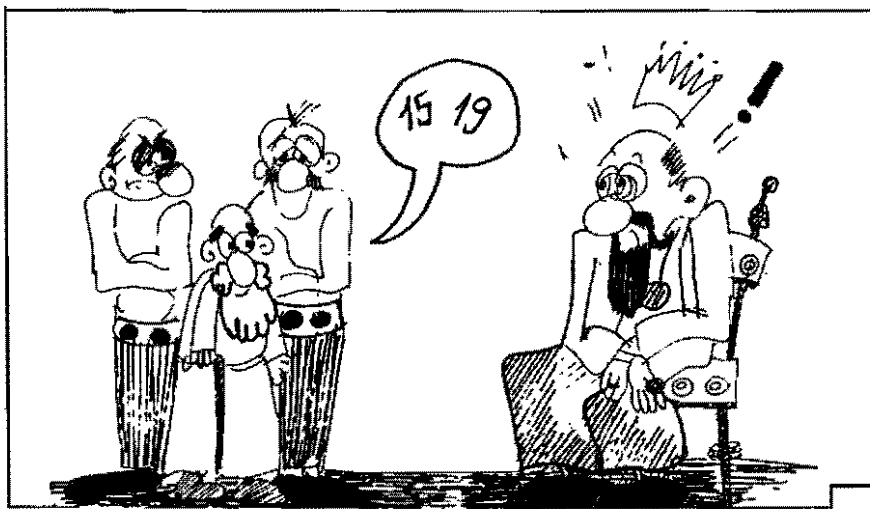

Observe

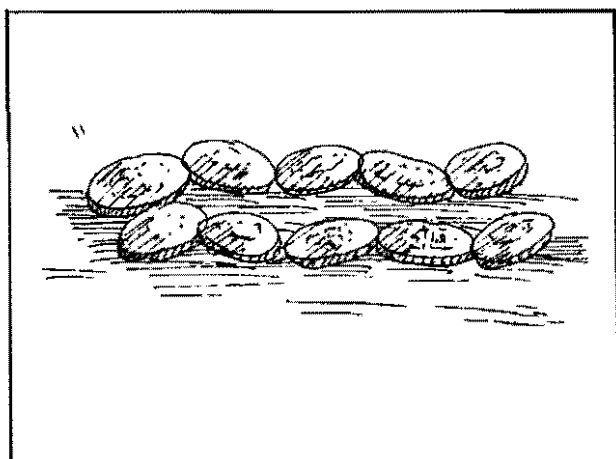

10u = 1d



1d

d	u
1	0



Observe

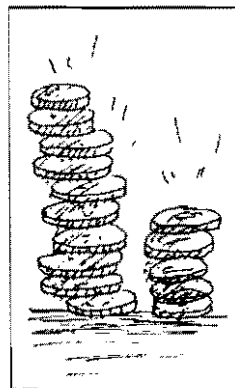
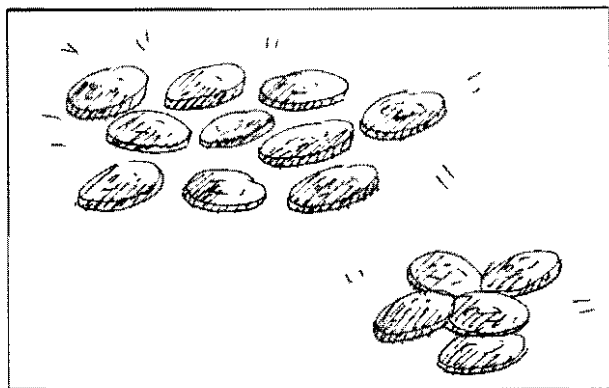

d	u
1	5

1d 5u



Complete

15 15 15

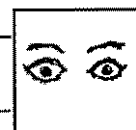

Observe

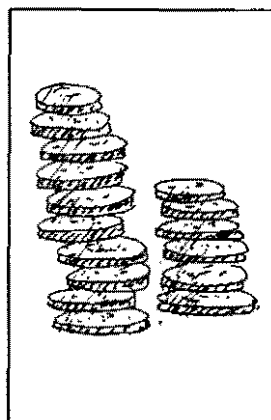
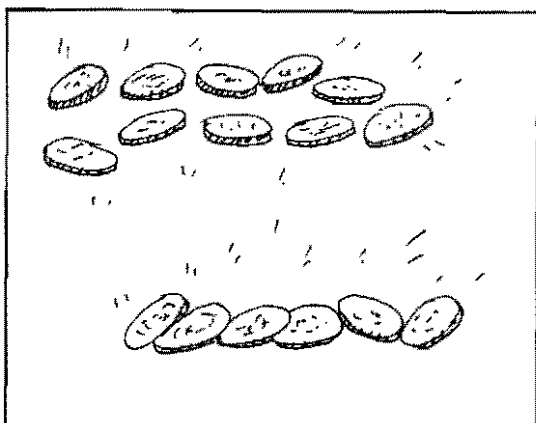

d	u
1	6

1d 6u



Complete

16 16 16



Observe

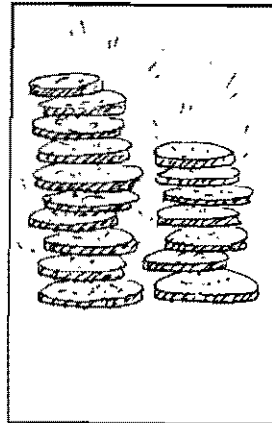
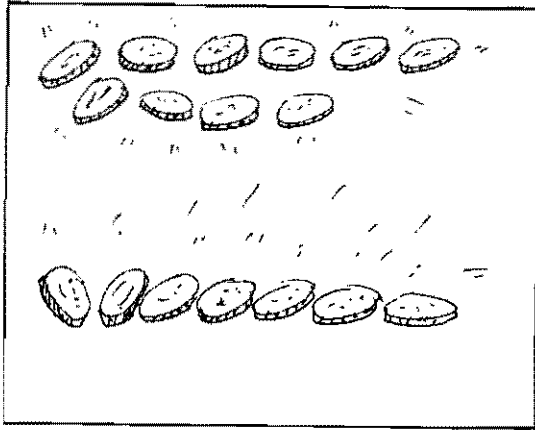

d	u
1	7

1d 7u



Complete

17 17 17



Observe

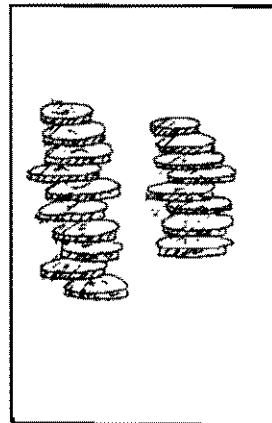
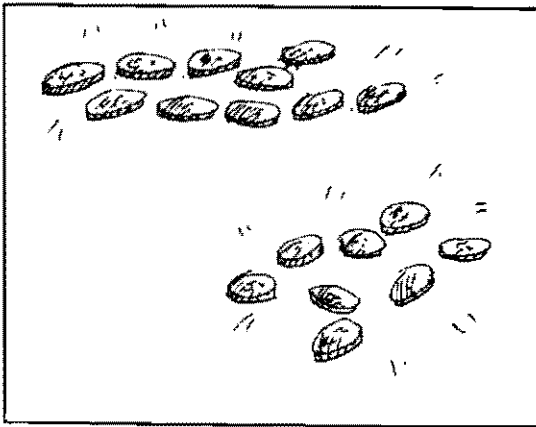

d	u
1	8

1d 8u



Complete

18 18 18

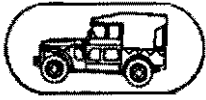

Observe

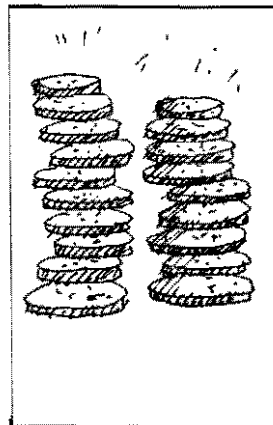
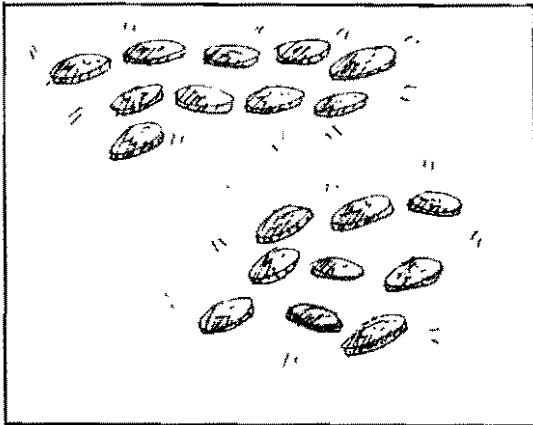

d	u
1	9

1d 9u

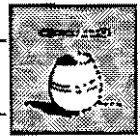

Complete

19 19 19

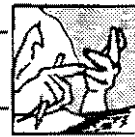

Cuenta



Escriba

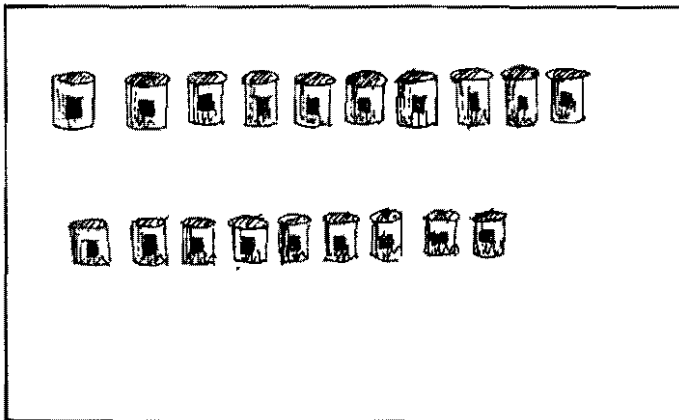

19



d	u

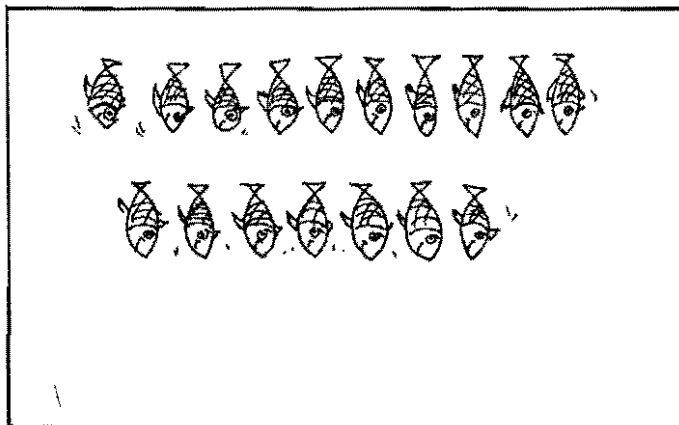

○



d	u



Cuenta



Escriba

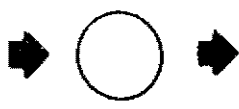
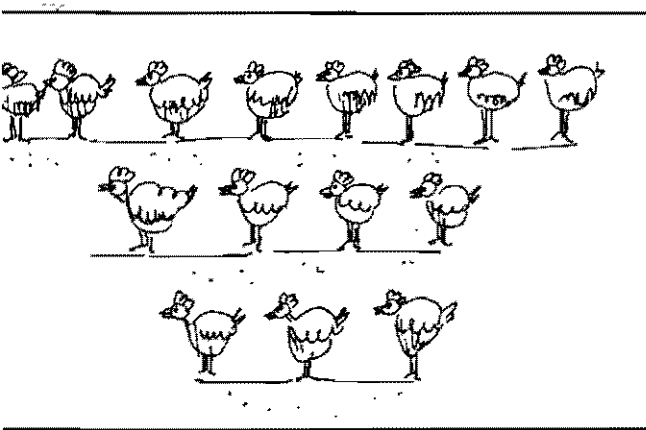

d	u

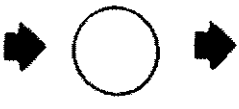
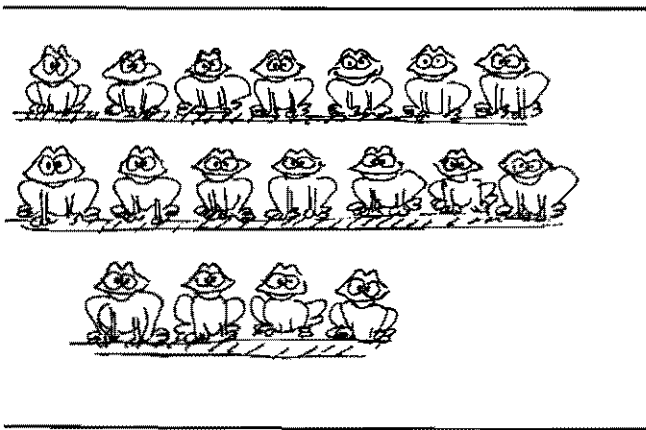

d	u

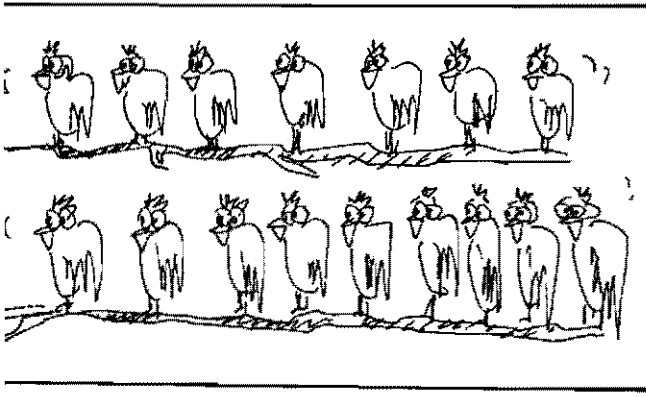

d	u



Escriba

10 11 12 13 14 15 16 17 18 19

10 \_\_\_\_\_ 15 \_\_\_\_\_ 18 \_\_\_\_\_

\_\_\_\_\_ 13 \_\_\_\_\_ 19





Escuche



Observe

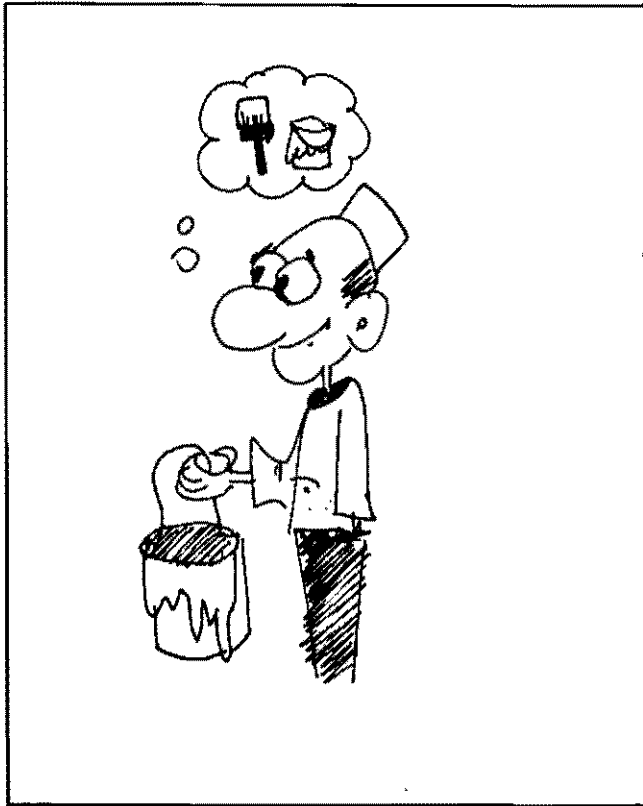



Compruebe

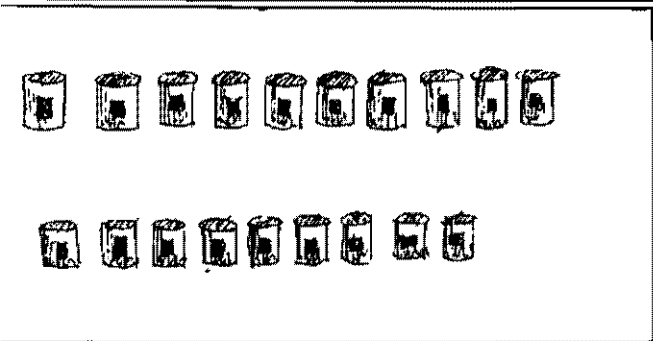

➔ 19 ➔

d	u
1	9

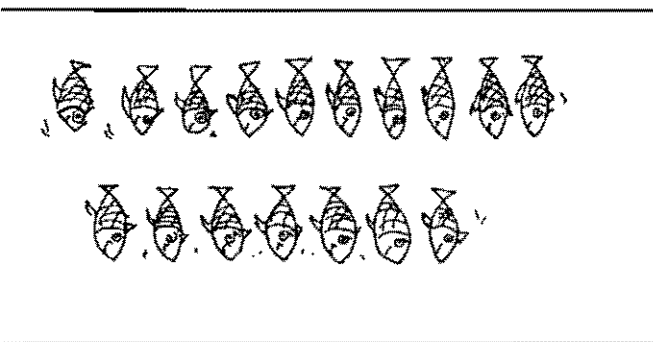

➔ 17 ➔

d	u
1	7

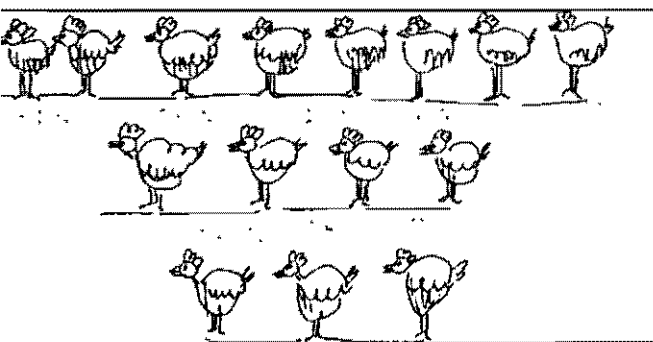

➔ 15 ➔

d	u
1	5

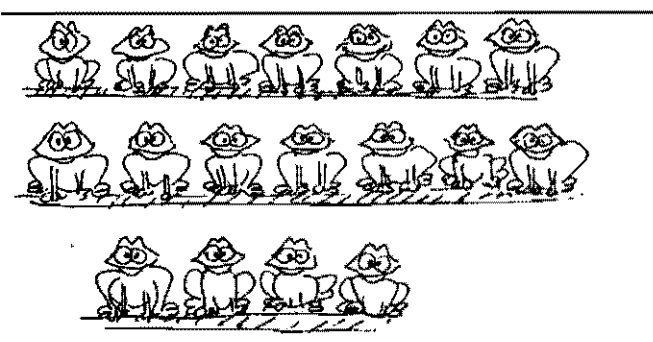

➔ 18 ➔

d	u
1	8

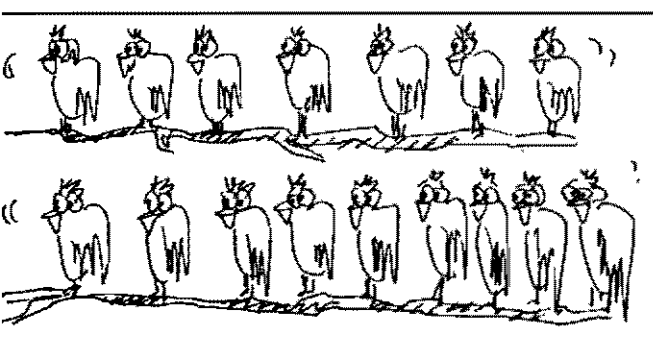

➔ 16 ➔

d	u
1	6



Escuche



Cuenta



Escriba

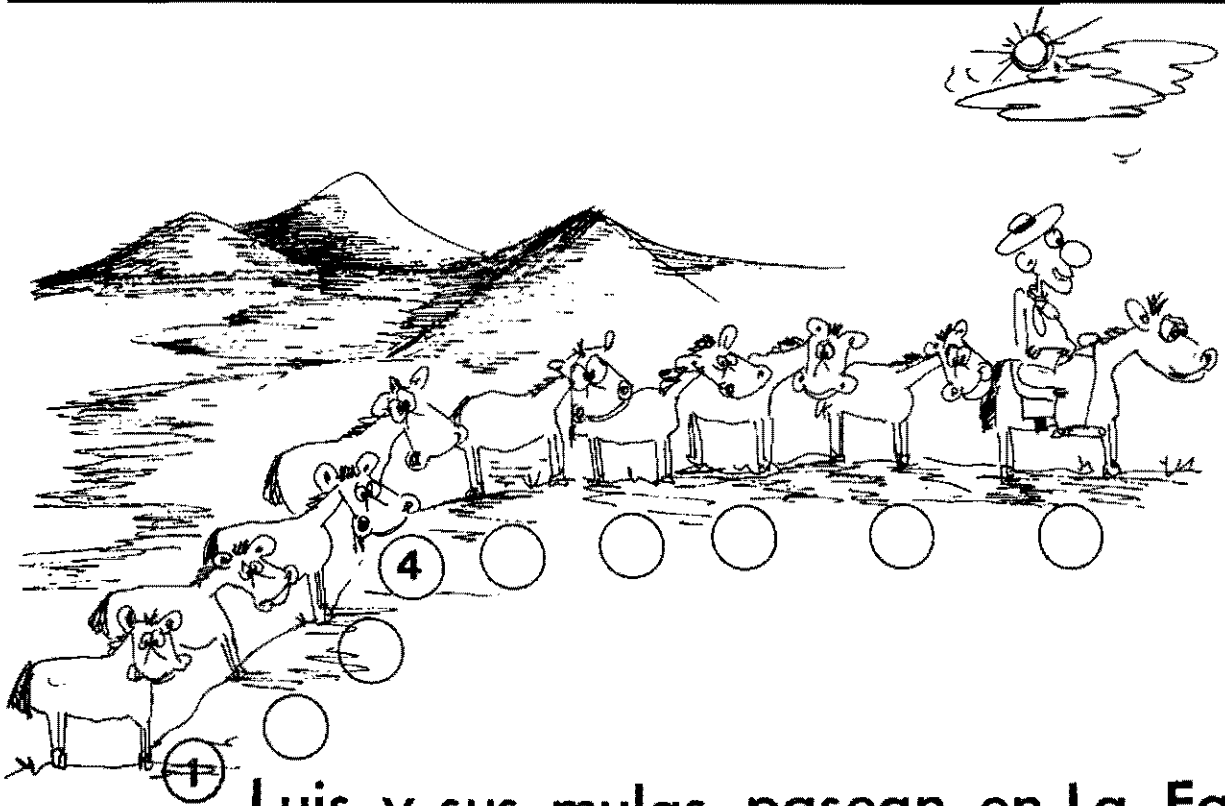

Luis y sus mulas pasean en La Falda



Cuenta



Escriba





Cuente



Escriba



A large, curved path divided into 18 numbered segments, designed for a counting and writing activity. The path starts at the top left and ends at the bottom right. Each segment contains a number and a small illustration. There are several empty circles along the path, likely for placing objects or markers.

1		3	4	5		7
						8
						10
						12
						13
						15
						17
						18

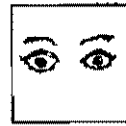

Observe



Lea

el



los



la



las

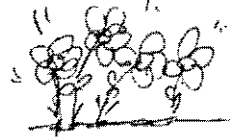

Observe



Escriba

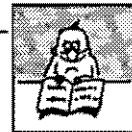
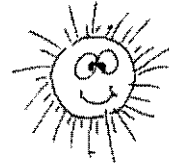
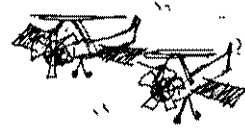

Lea



Escriba

Lola usa sal.

--	--	--

Elsa sale sola.

--	--	--

Luis pisa el palo.

--	--	--	--



Escuche





Compruebe



13



18



10



15



12

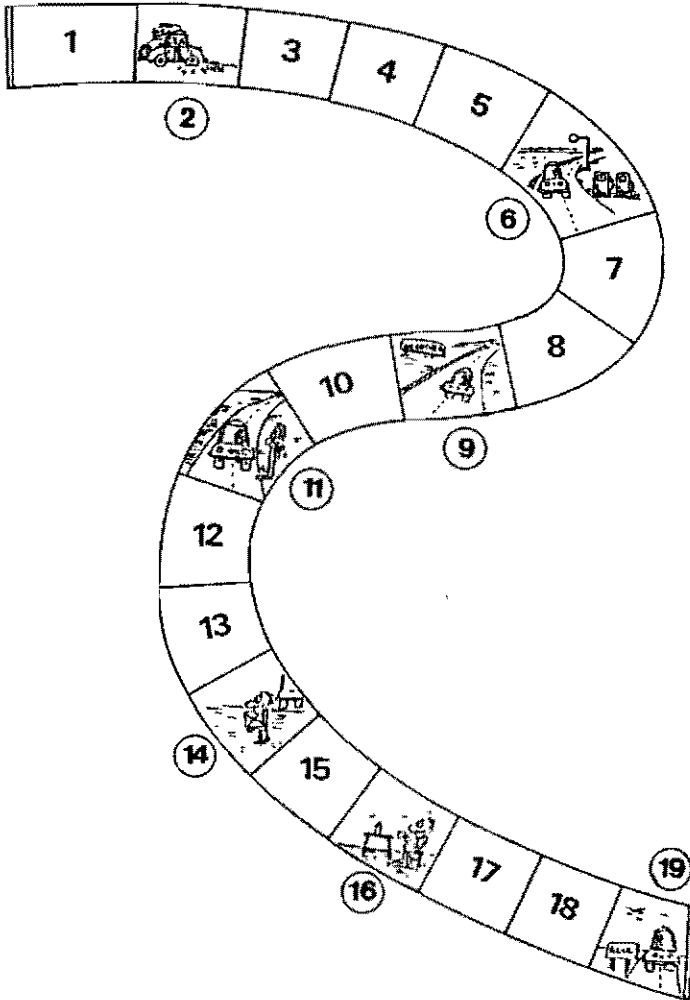

la



los



las



el





Escuche



Observe



Lea

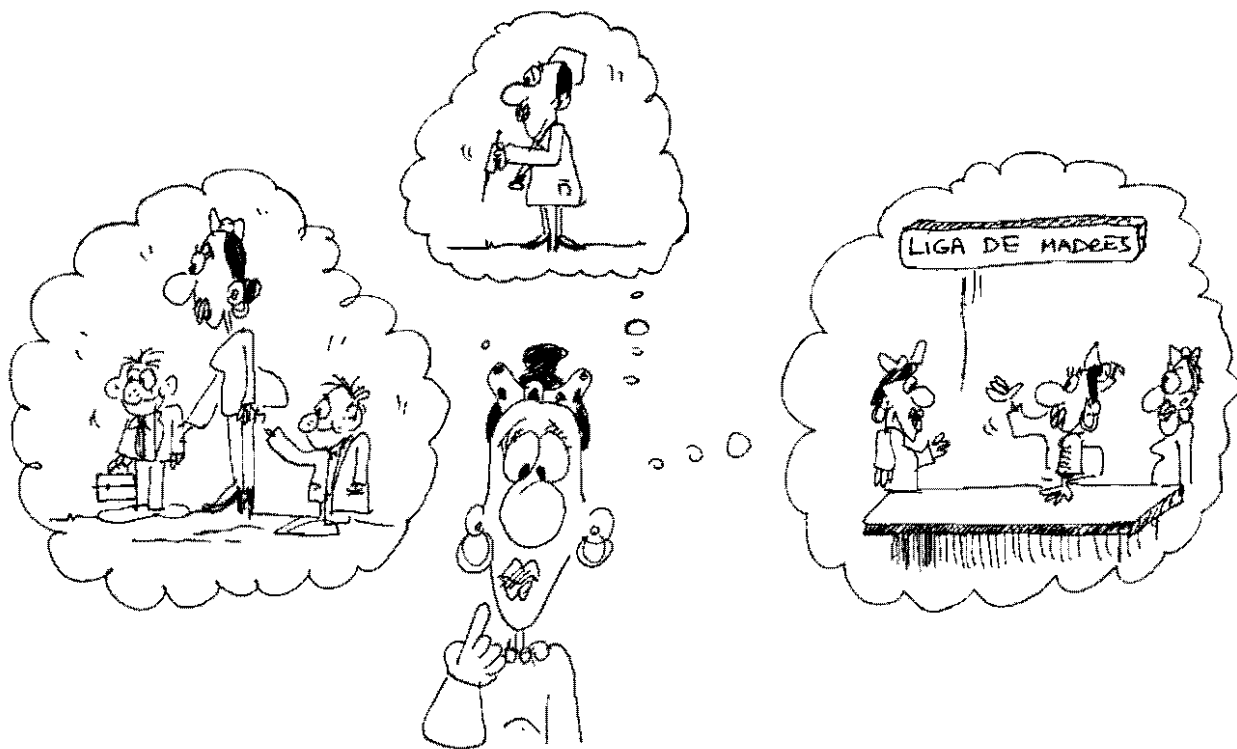

Nina piensa en su país.

Nina

Ni	na
----	----

no ne nu ni na

No Ne Nu Ni Na

on en un in an





Lea



Escriba

Eso opina Ana.

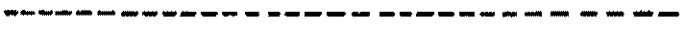

Elena se pasa el peine.



El esposo pasea en un asno.

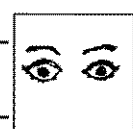

Observe



Escriba

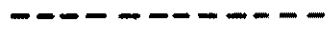
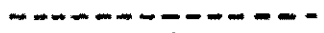
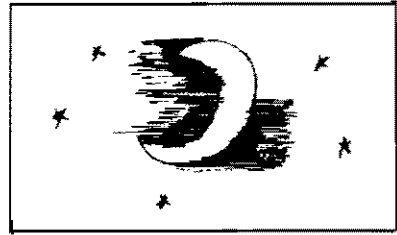
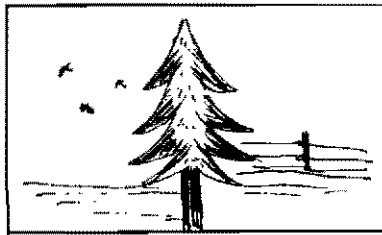
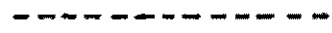
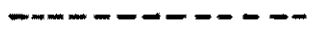
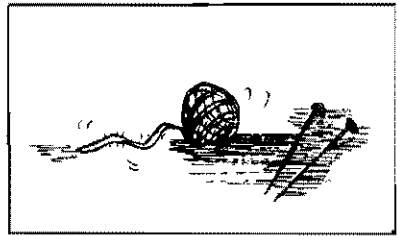
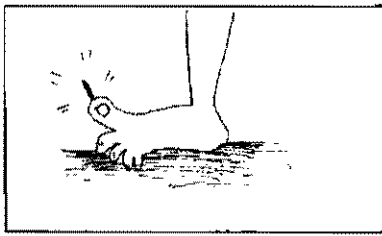



Lea

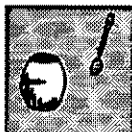

Relacione



Escriba



Sonia lee.



Luis piensa.



-----

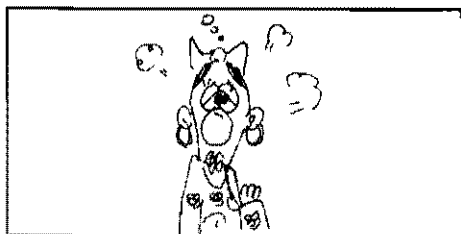

-----



Lea

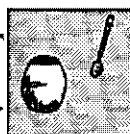

Relacione



Escriba

- an
- en
- in
- on
- un

Elena pone sal .... la sopa.

Lalo pisó .... peine.

En la isla ponen .... pino.

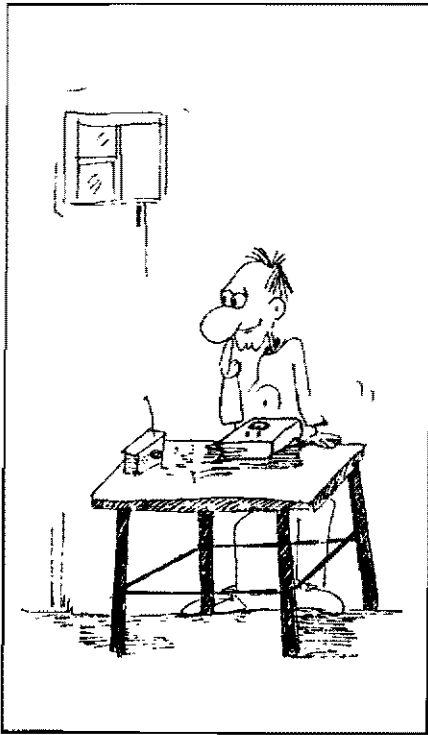

Compruebe



espina



lana



pino



luna



Sonia lee.



Luis piensa.



Luis lee.



Sonia piensa

- an
- en
- in
- on
- un

Elena pone sal en la sopa.

Lalo pisó un peine.

En la isla ponen un pino.



Escuche



Observe

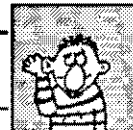
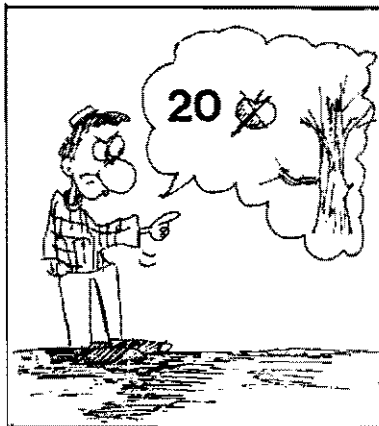
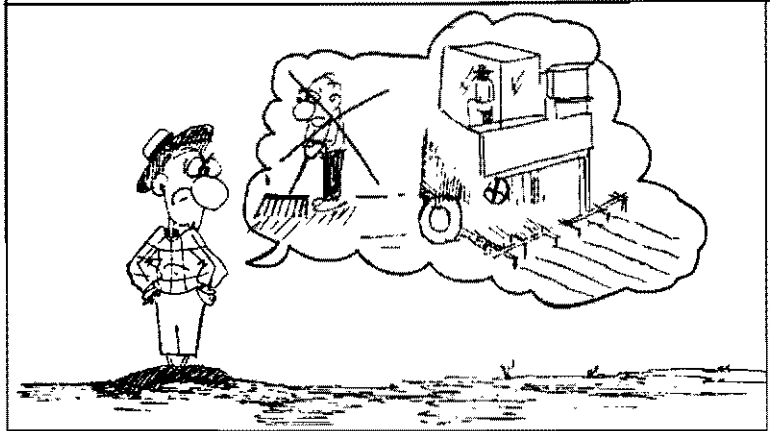

Escuche



Observe

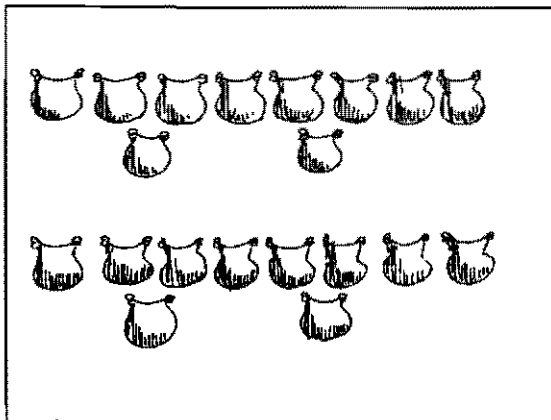

20

d	u
10	

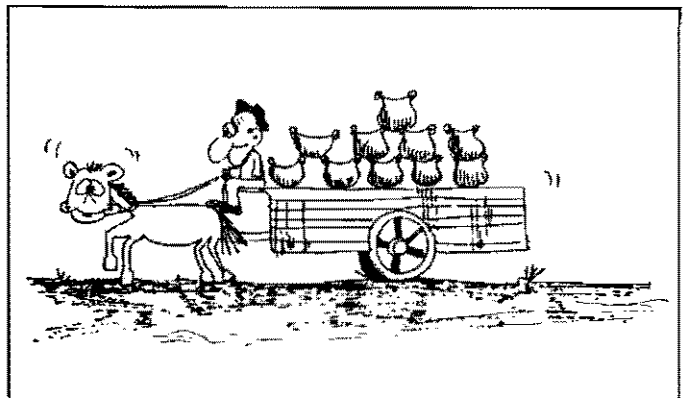

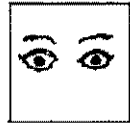

Observe

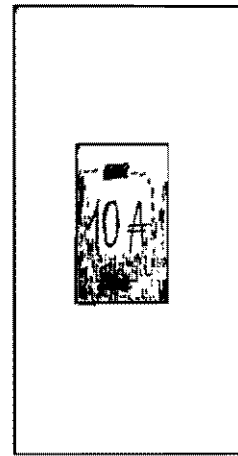
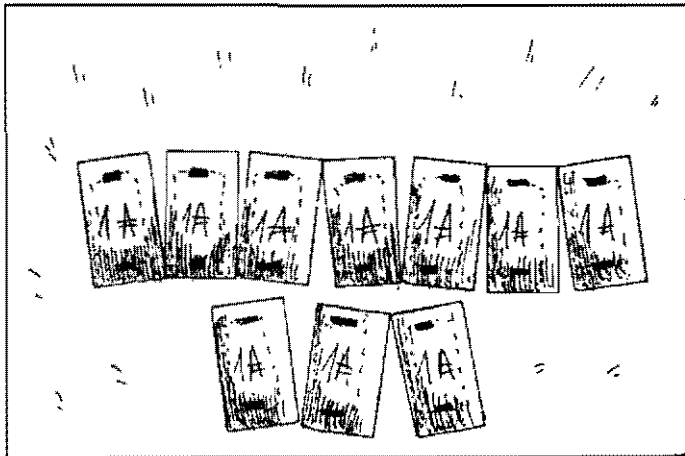

$$10u = 1d$$



Observe

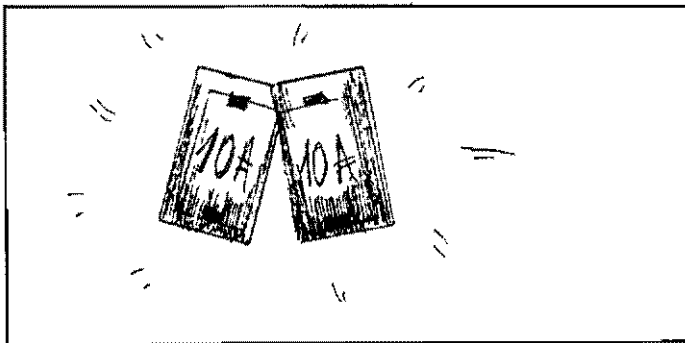

d	u
2	0



Escriba

20



Observe

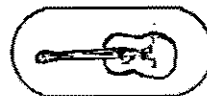

21



d	u
2	1



Escriba

21



Observe

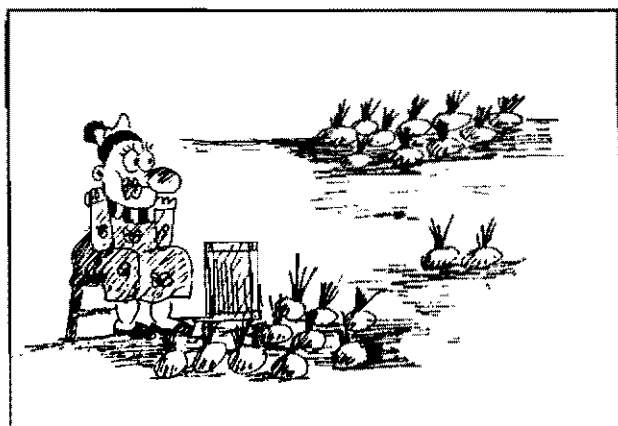

22



d	u
2	2

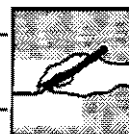

Escriba

22



Observe

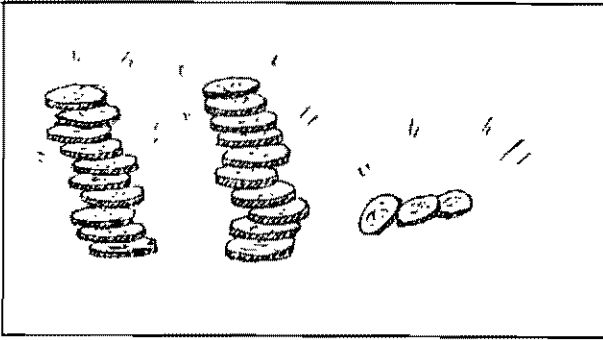

d	u
2	3

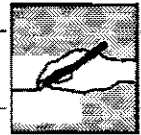

Escriba

23



Observe

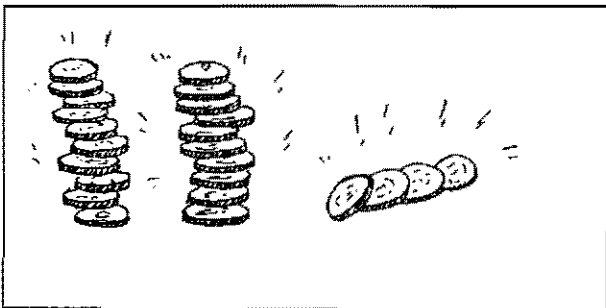

d	u
2	4



Escriba

24



Escriba

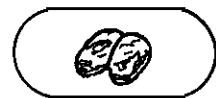

20 21 22 23 24

\_\_\_ 22 \_\_\_

20 \_\_\_



Cuenta

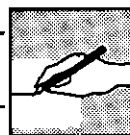

Escriba

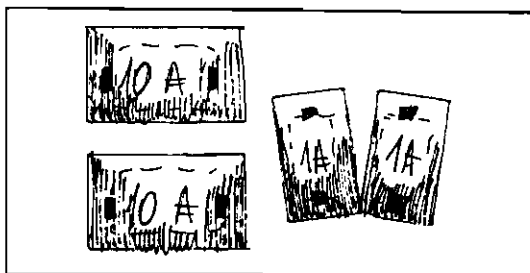

d	u

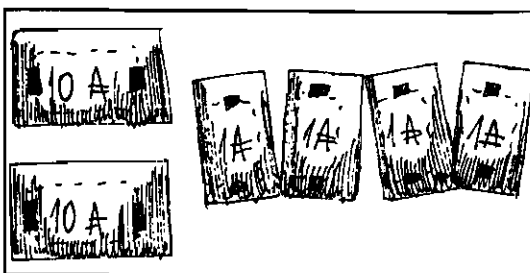

d	u

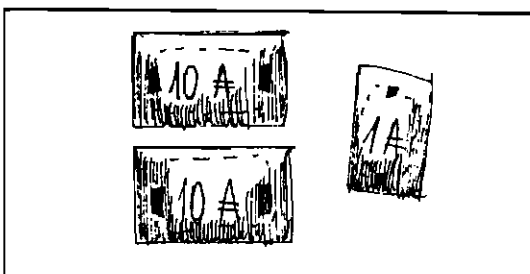

d	u

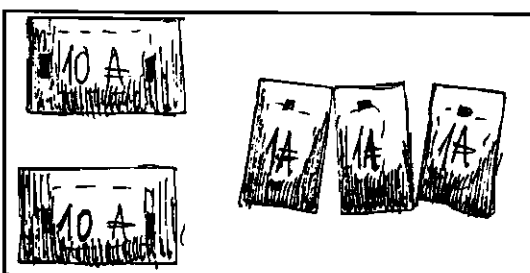

d	u





Compruebe

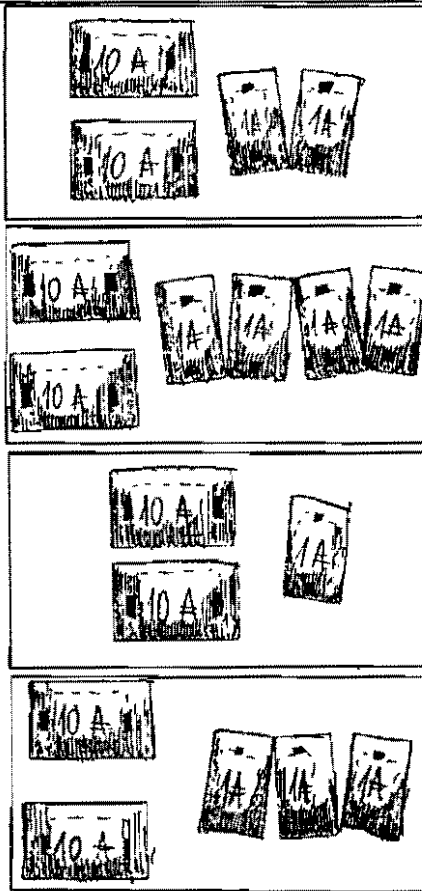

22



d	u
2	2



24



d	u
2	4



21



d	u
2	1



23



d	u
2	3



Escuche



Observe

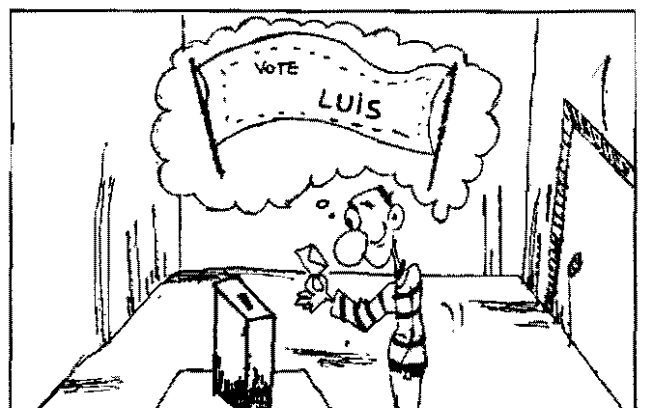
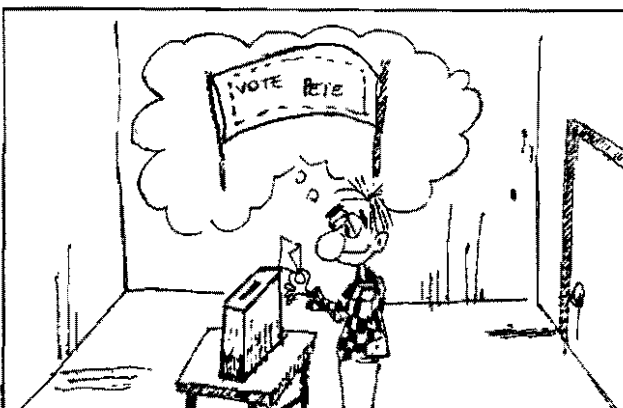



Escuche



Observe



Escuche



Lea

Veo un ave.  
Vive en la selva.

ave

a	ve
---	----

ve va vi vu vo

Ve Va Vi Vu Vo



Lea



Relacione

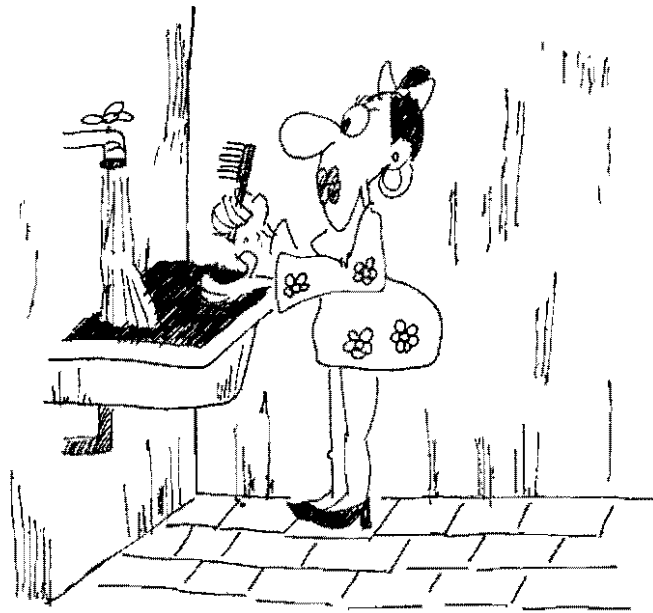

Silvia lava su

pava

vaso

nave

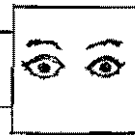

Observe

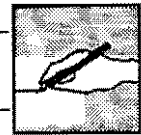

Escriba



vuelo

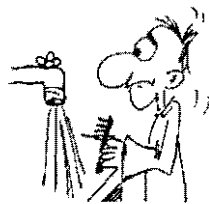

lavo



\_\_\_\_\_

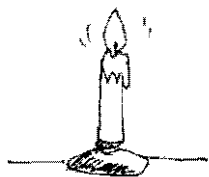

vue	lo
la	vo
vi	
ve	
va	



Lea



Escriba



Luis pisa uvas

El ave vuela

Papá lava pelones

Ese peón es valioso

Ana apila vasos

Eva vive en la Puna

Silvio pasea solo

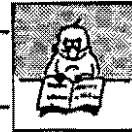

Lea



Escriba

La ..... es espesa

El ..... vuela

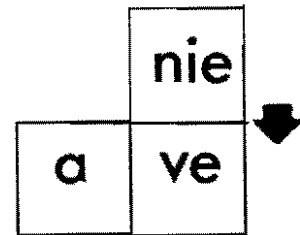

Analía pone ..... en la salsa

Susana ..... sola en la selva

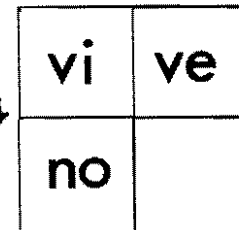

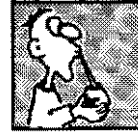

Comprueba

Luis lava vasos.

El peón vive solo.



Comprueba

La nieve es espesa.

El ave vuela.

	nie
a	ve



Analía pone vino en la salsa.

Susana vive sola en la selva.

vi	ve
no	



Comprueba



vuelo



lavo



vino

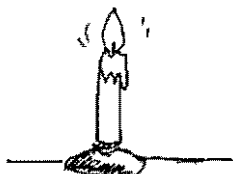

vela



vaso

vue	lo
la	vo
vi	no
ve	la
va	so



Escuche



Observe

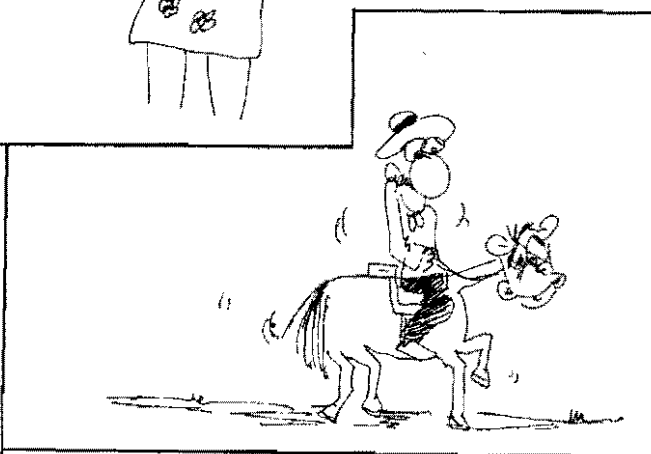
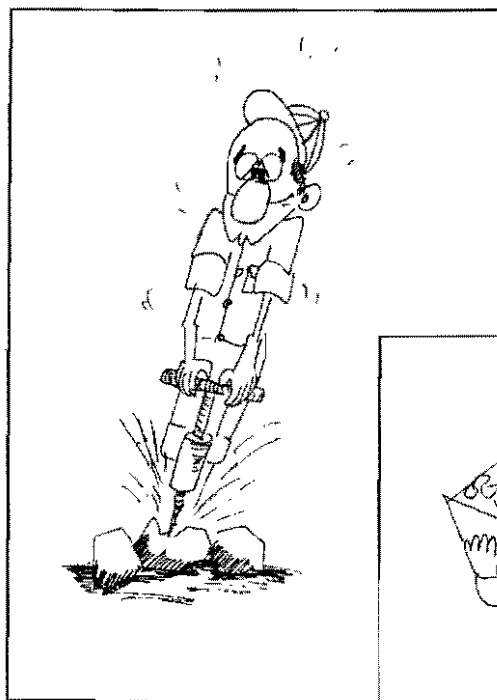



Observe



Ciudad de Buenos Aires



Lago Argentino y Glaciar Moreno



Palmar de Colón



Camino a Cafayate

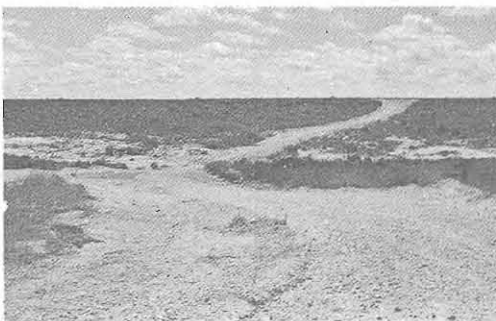

Cruce de la Ruta Provincial 23 con el río Chadiileuvú



Cataratas del Iguazú



Escuche



Lea



Argentina es nuestra casa.

casa

ca	sa
----	----

co

cu

ca

Co

Cu

Ca

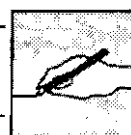

Escriba

---



---



---



---



---



---



---



---



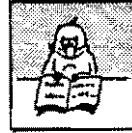
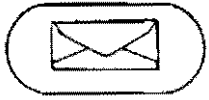

Lea



Escriba

pino

\_\_\_\_\_

cana

cana

\_\_\_\_\_

sal

\_\_\_\_\_

pesca

\_\_\_\_\_

pus

\_\_\_\_\_

naipe

\_\_\_\_\_

colonia

\_\_\_\_\_

vena

\_\_\_\_\_

vacuna

\_\_\_\_\_



Lea



Escriba

	va	
a	cu	sa
	na	

	es	
vo	ca	les
	lón	

	pe	
Ni	co	lás
	so	

\_\_\_\_\_

\_\_\_\_\_

\_\_\_\_\_



Lea



Cuenta



Relacione

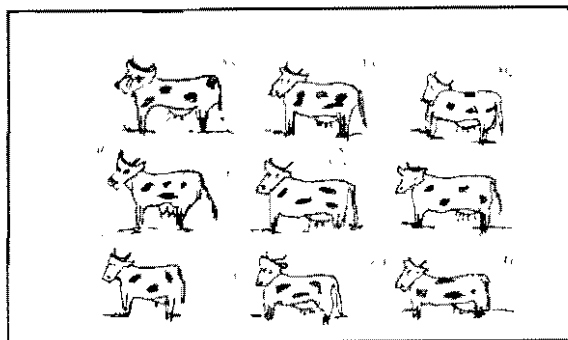
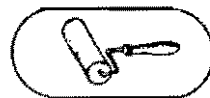

Una
Seis
Nueve

cu	na
pi	cos
va	cas

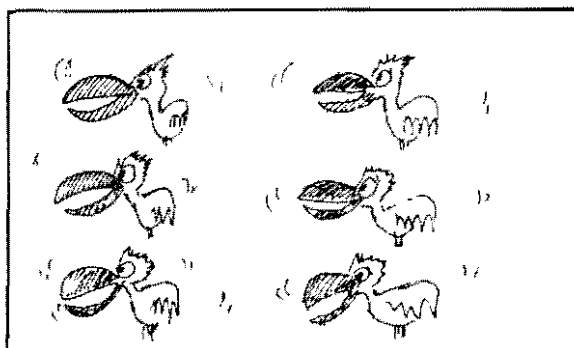
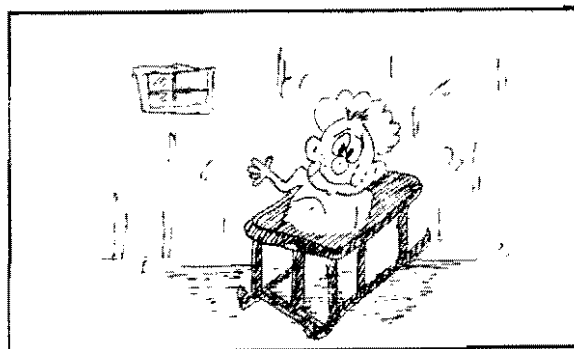

Lea

Al  se le alisó la cola.

El peón lee un .



Escuche



Observe



Compruebe

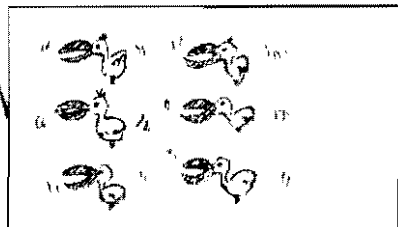
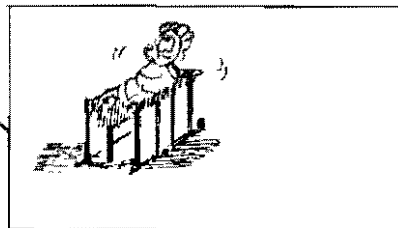
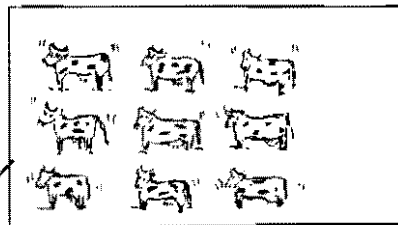

Una	cu	na
Seis	pi	cos
Nueve	va	cas

pino

cana

sal

pesca

pus

naipe

colonia

vena

vacuna

cana

pesca

colonia

vacuna



Escuche



Observe

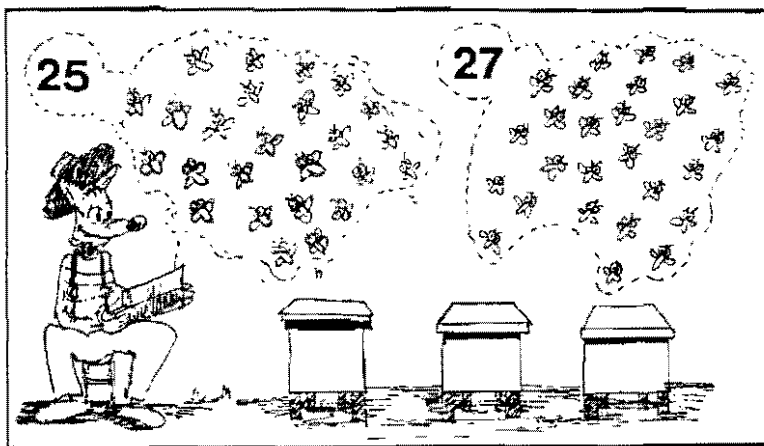
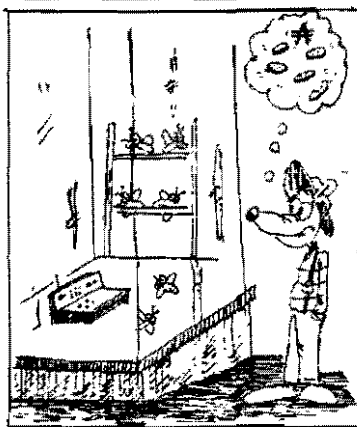
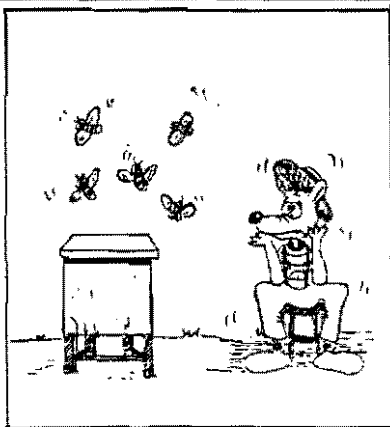
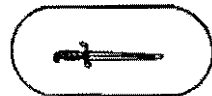

Escuche

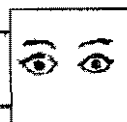

Observe



d	u
2	5

25



Observe



Escriba

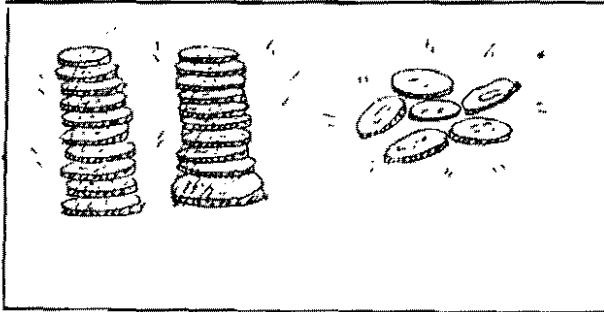

26



d	u
2	6

26



Observe



Escriba

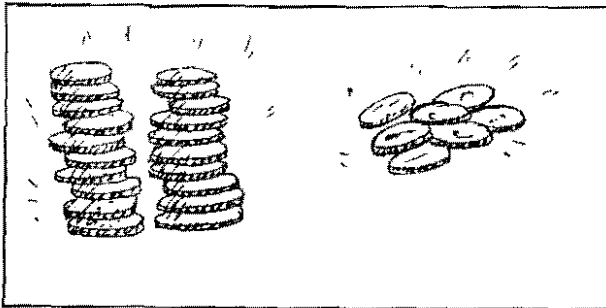

27



d	u
2	7

27

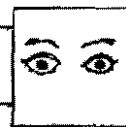

Observe



Escriba

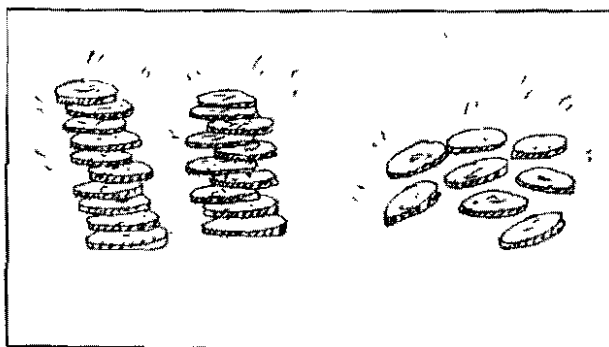

28



d	u
2	8

28



Observe



Escriba

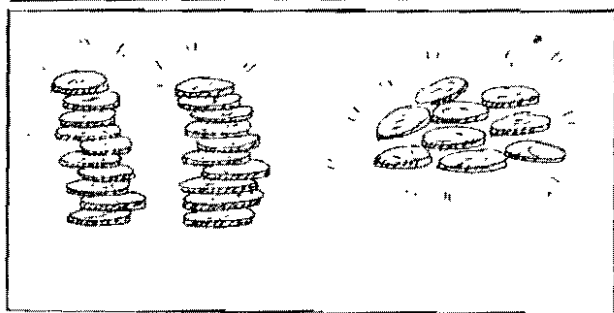

29



d	u
2	9

29

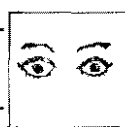

Observe

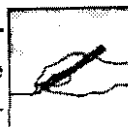

Escriba

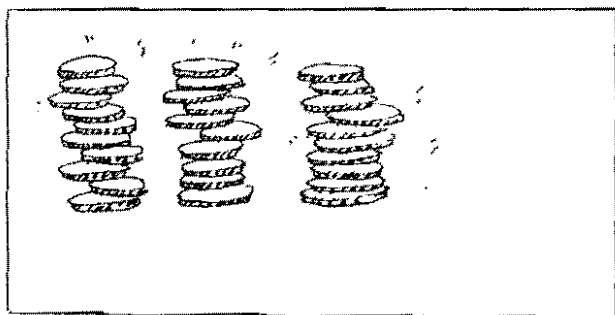

30



d	u
3	0

30

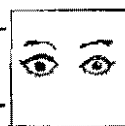

Observe



Escriba

20 21 22 23 24 25 26 27 28 29 30

\_\_\_ 23 \_\_\_ 26 \_\_\_ 29 \_\_\_

20 \_\_\_ 24 \_\_\_ 28 \_\_\_



Cuenta



Escriba

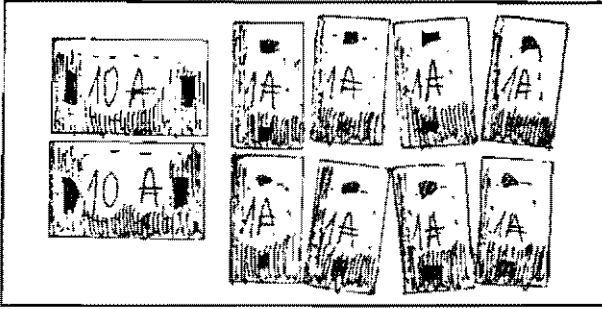

d	u

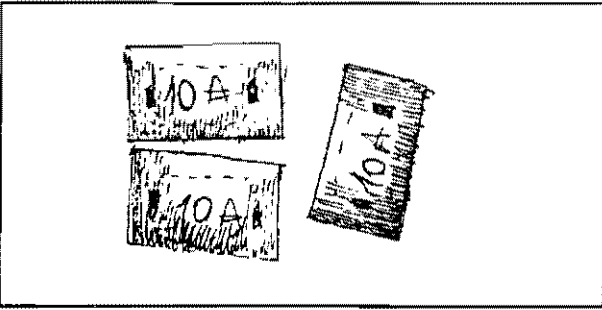

d	u

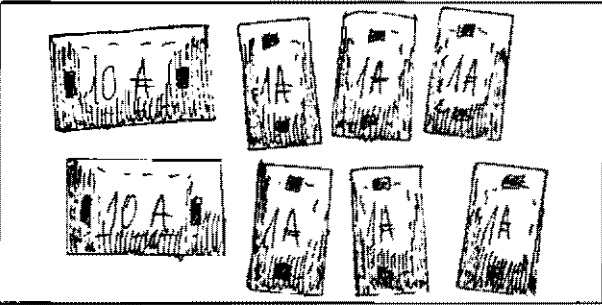

d	u

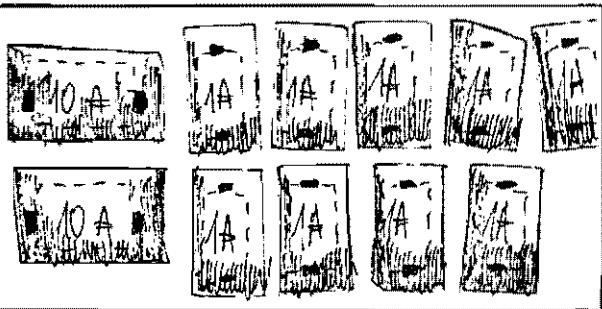

d	u

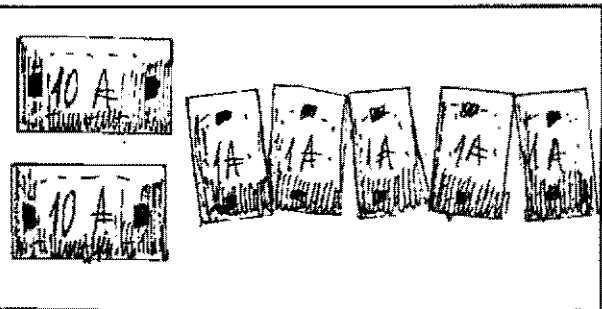

d	u



Escuche



Observe

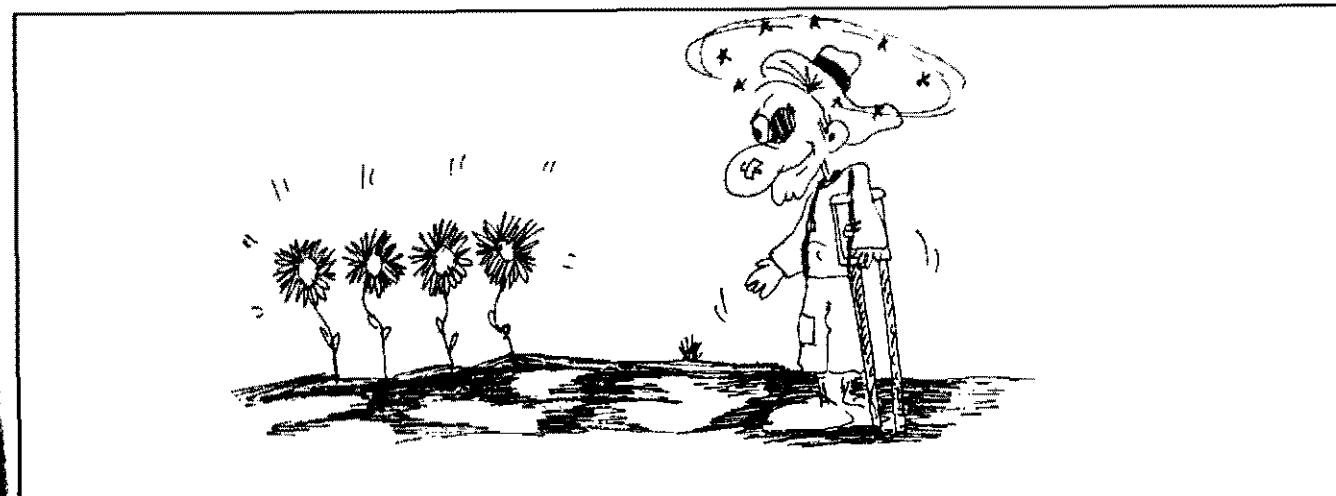
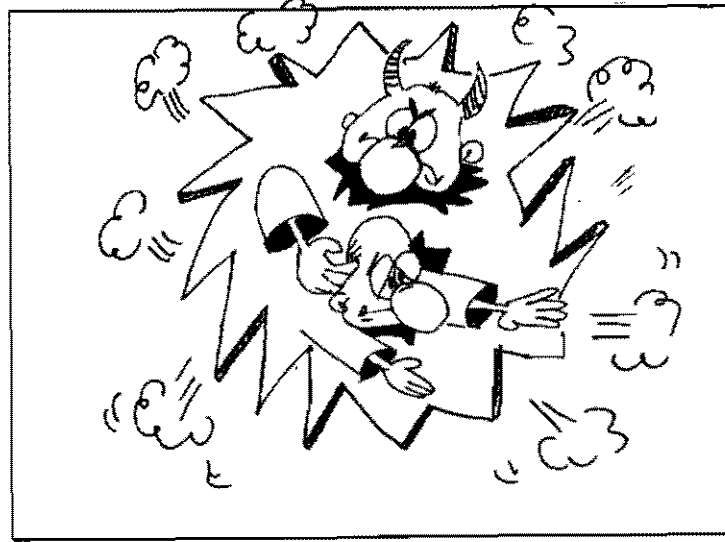
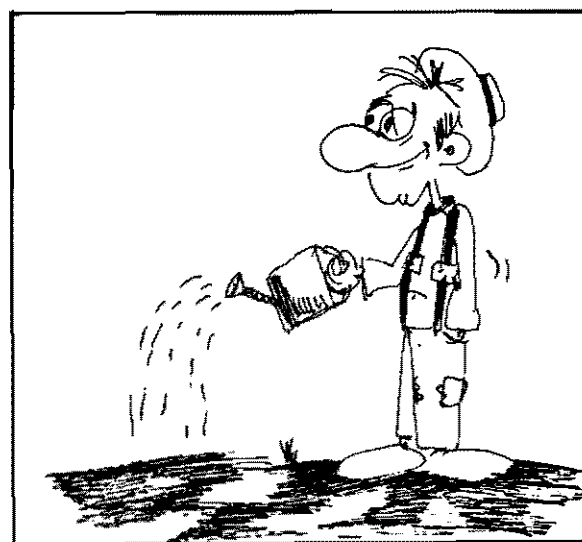



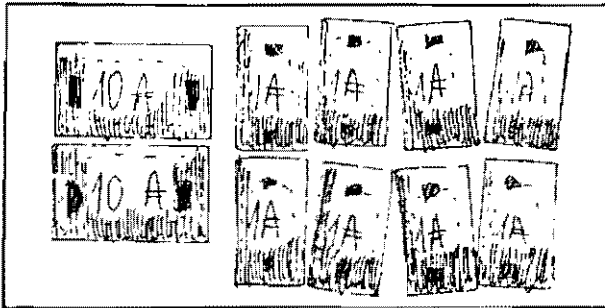
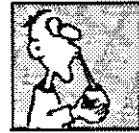

28



d	u
2	8

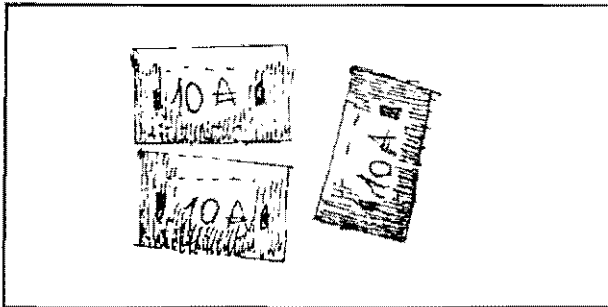

30



d	u
3	0

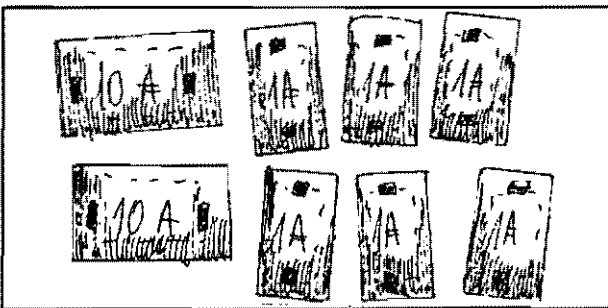

26



d	u
2	6

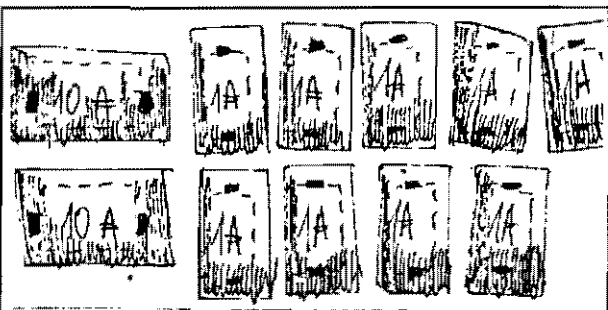

29



d	u
2	9

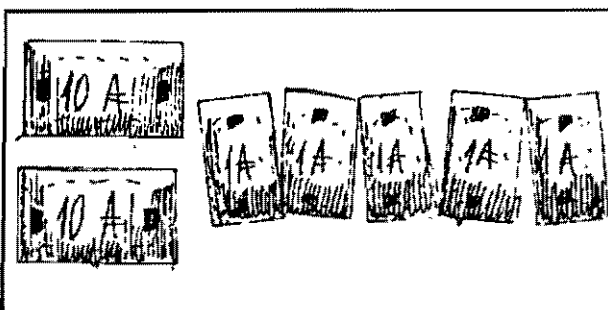

25



d	u
2	5

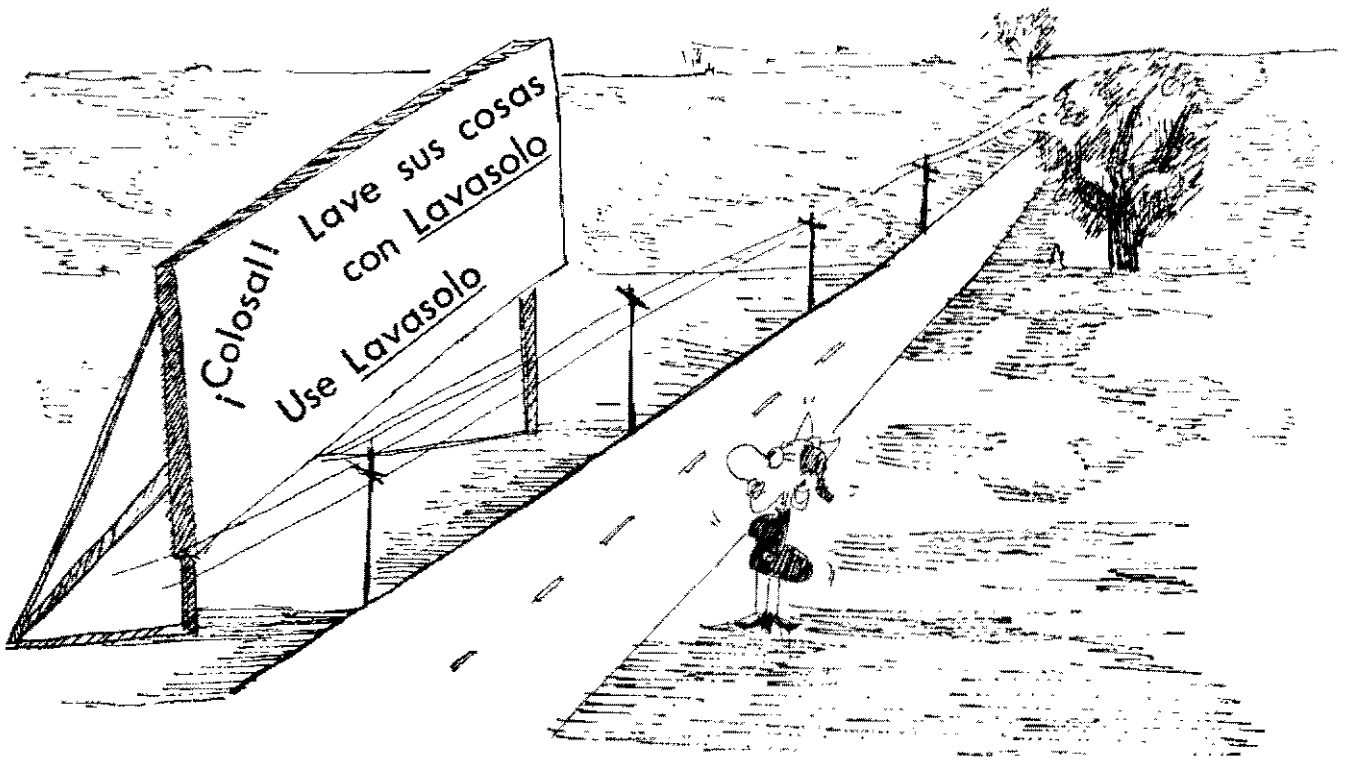

Elena lee un aviso.

Elena sale con su esposo Nicolás.

Vuelven a las seis con los nueve envases.

Elena lava con el nuevo Lavasolo sus cosas : los pisos, los vasos, la pava.

¡Sólo Nicolás se salvó!

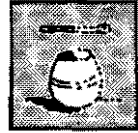

Complete

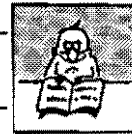
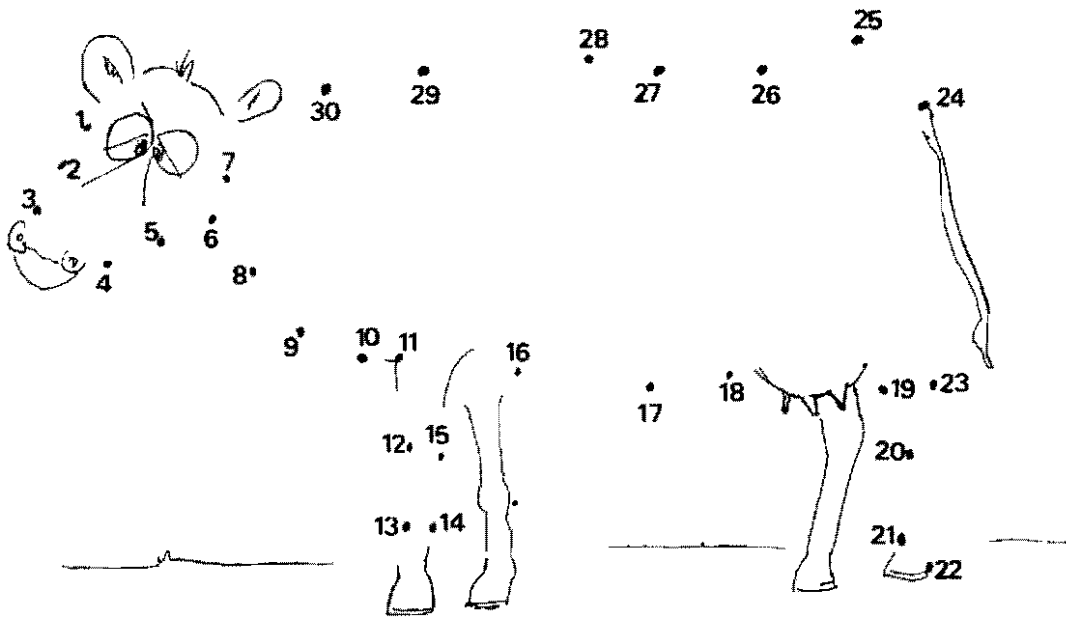

Lea



Escriba

se → ca  
→ co  
→ cu

-----

va → ca  
→ co  
→ cu

-----

ve → na  
→ ne  
→ ni  
→ no  
→ nu

-----

vi → va  
→ ve  
→ vi  
→ vo  
→ vu

-----



Escuche



Escriba

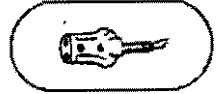

44	67	27	80	9	90
7	69	77	89	60	45
24	70	98	30	78	40
38	47	50	4	56	49
44	10	99	20	75	84
5	45	65	48	37	57



Cuenta

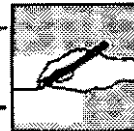

Escriba

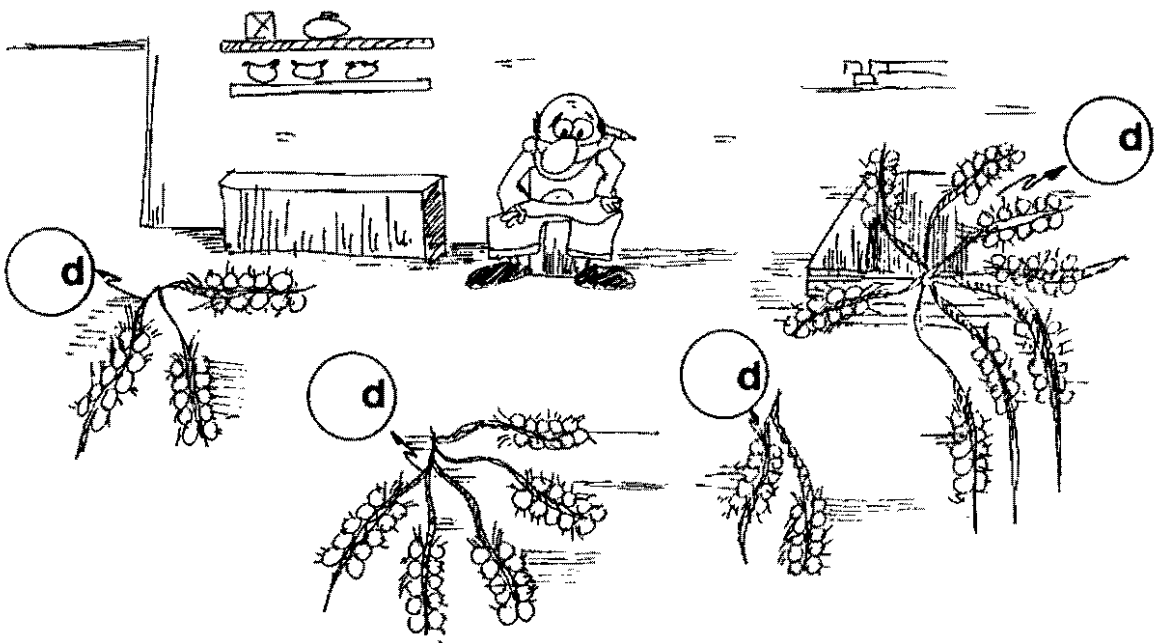



Observe



Escriba



Lea

↓

1			
2			
3	vi	no	
4			



1

2

3

4



Escuche

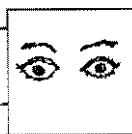

Observe

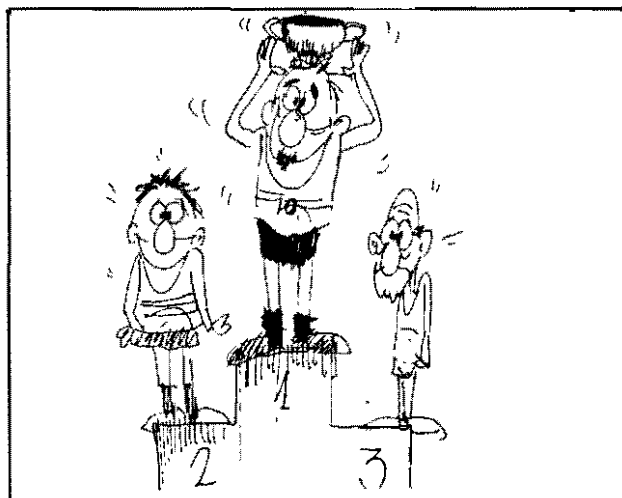
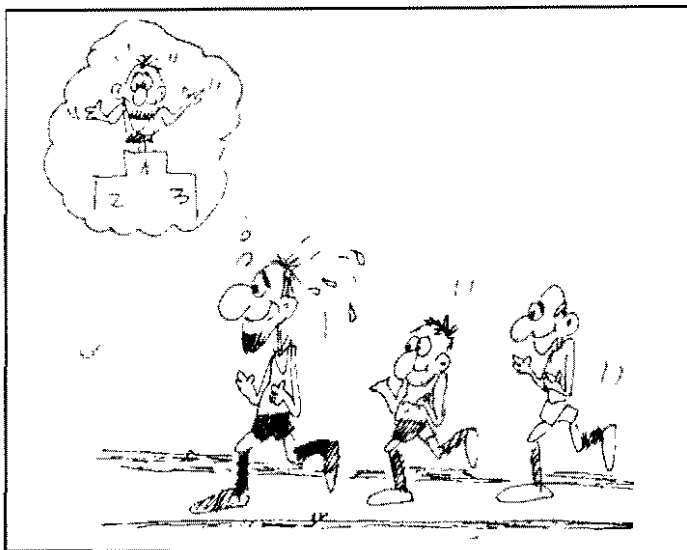
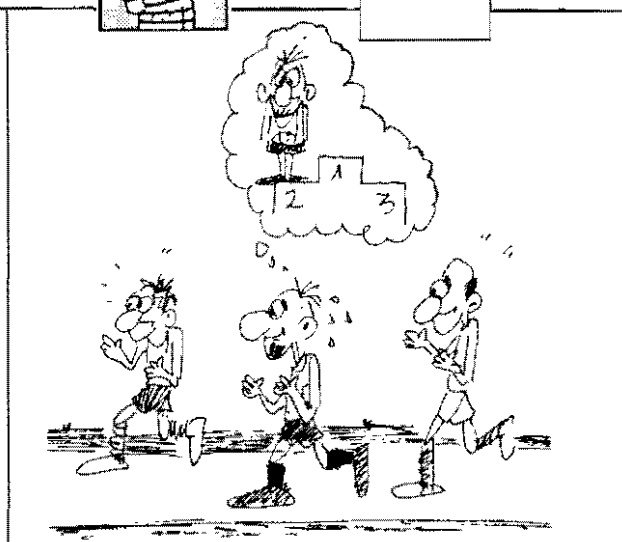
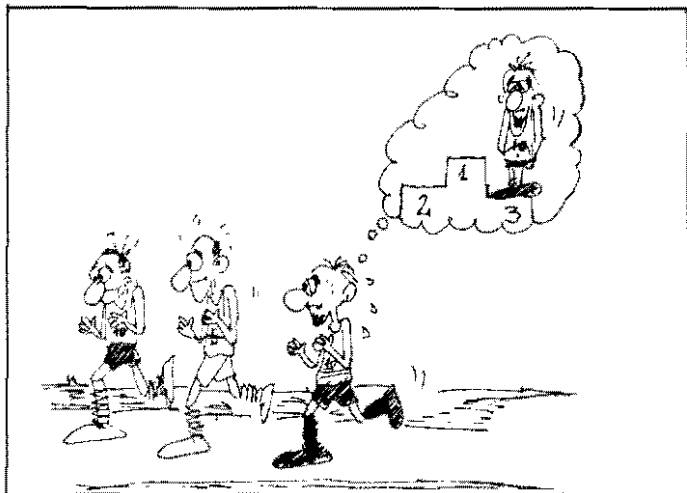



Lea



Relacione



Escriba



Los novios

vuelve

pecosa.

Las vacas

va

solo.

Nicolás

se casan

a las nueve.

Los vasos

vuela

a pie.

Las uvas

pasean

en avión.

Coca → se lava

a su casa.

Paco

son

el saco.

La escuela

cose

la novela.

1 Coca se lava a las nueve.

2 \_\_\_\_\_



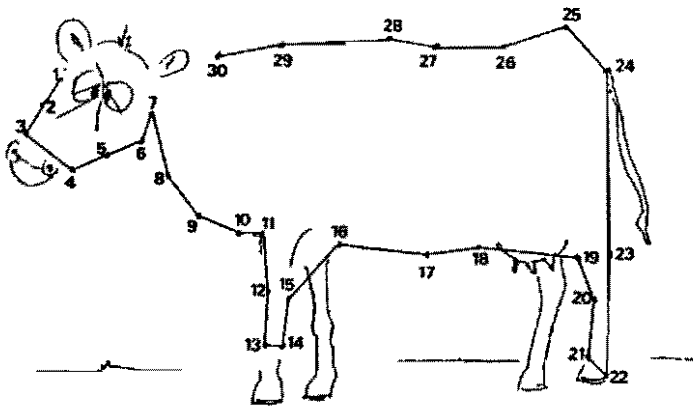
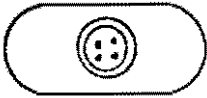

3 \_\_\_\_\_

4 \_\_\_\_\_



44	67	27	80	9	90
7	69	77	89	60	45
24	70	98	30	78	40
38	47	50	4	56	49
44	10	99	20	75	84
5	45	65	48	37	57

↓

1	es	pi	na	_____	1	
2	pi	no		_____	2	
3	vi	no		_____	3	
4	ca	sa		_____	4	

espino sa

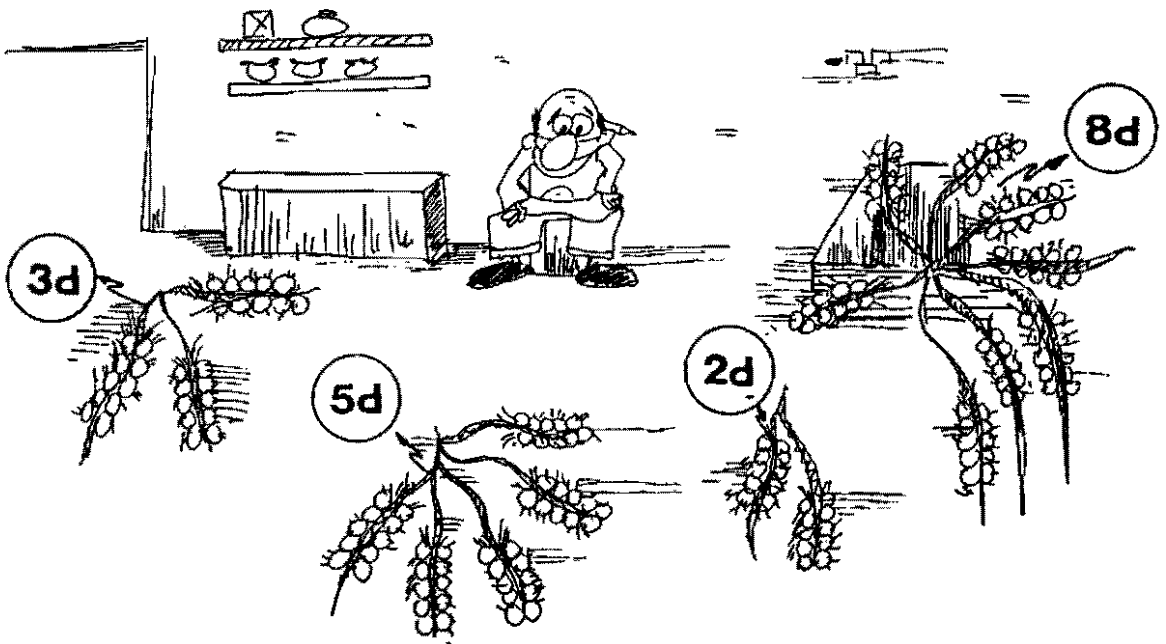



---

Esta obra se terminó de imprimir en los  
Talleres Gráficos del Instituto Geográfico Militar  
el 15 de agosto de 1988 con un tiraje de 105.000 ej.

---